

Please read this manual carefully before using the system

Use notice:

1. On the packing, please check the system have damaged during the transit, whether the content listed on the packing list and the items in the cabinet.
2. This manual applies to Beijing STARFIRE control technology co., LTD., peak production of SF-2100C-AH NC cutting machine system.
3. Please check whether the power grid voltage is correct. Between the grid and the system to use AC220V isolation transformer, to ensure the safety of the system reliable work and personnel.
4. Numerical control system requires working environment temperature 0 °C ~ + 40 °C, relative humidity of 0 ~ 85%. Such as it works high temperature, high humidity and corrosive gases under the environment, need to take special protection.
5. CNC system wiring to correct parts, good ground contact.
6. CNC system does not allow charged plug all cable at the back of the case, the resulting consequences. Or company refused to guarantee.
7. CNC system output port at the back of the line, does not allow with other power cord short circuit, otherwise will be burned CNC.
8. Under the environment of high dust, dust the machine needs to be done protection, and require regular cleaning dust, as far as possible to ensure that the numerical control system clean.
9. NC system should be managed by personnel, should carry on the training to operators.
10. CNC system is not allowed to use inner the AC/DC power supply to connection to other electrical appliances.
11. In case of problem, please contact with the company. Don't in unfamiliar situations to tear open outfit, the transformation system.
12. The maintenance system and machine tools, daily maintenance and check once per class. Every month performs maintenance level 2. Every six months perform maintenance level 1.
13. CNC system Settings of various parameters, we will strictly in accordance with this manual or order of added set. Such as setting parameters within the prescribed scope, or can make the operation of the CNC system and even damaged.
14. The LCD panel of the system is fragile goods, pay attention to during the process of using LCD for protection.
15. This system technical indicators in the event of a change, without prior notice.
16. Note:
System's USB port output power is very small, only for the use of USB flash drive, can't pick up any other USB devices, in case of damage.
17. Special announcement:
Warranty, the warranty of this product range is from the date of delivery, 12 months, according to the instructions allow what happened under the condition of fault.

Warranty and warranty beyond the treatment of the failure is a subscription service.
The following case is beyond the scope of warranty:

A: Use breach of artificial damage

B: The damage caused by force majeure

Force majeure usually includes two cases:

The natural causes, such as lightning, flood, drought, storm, earthquake, etc.

Another: The social causes, such as war, strikes, government ban, etc.

C: Without permission, without authorization, remove the damage caused, modification, repair, etc.

18. The interpretation of this manual belongs to Beijing STARFIRE control technology co., LTD.

Catalogue

The first chapter: overview of system function

- 1.1 system function
- 1.2 technical indicators
- 1.3 the company's products supporting CNC cutting machine

The second chapter: system main menu

- 2.1 menu features
- 2.2 main menu illustration

The third chapter: automatic function

- 3.1 automatic way interface illustration
- 3.2 the function of automatic processing choose 8
- 3.3 start of automatic processing
- 3.4 automatic control and adjustment of cutting position in the process
- 3.5 the original track back processing
- 3.6 breakpoint recovery and double breakpoints recovery process
- 3.7 parts of function
- 3.8 the edge of the thick plate perforation

The fourth chapter: manual

- 4.1 interface description of manual way

The fifth chapter: editing function

- 5.1 editing menu illustration

The sixth chapter: programming function

- 6.1 shows of programming symbol
- 6.2 the coordinate system
- 6.3 G (basic preparation instructions)
- 6.4 M auxiliary function

The seventh chapter: parameter settings

- 7.1 parametric descriptions
- 7.2 velocity parameters
- 7.3 system parameters
- 7.4 flame parameters
- 7.5 plasma parameter setting
- 7.6 control parameter setting

The eighth chapter: gallery function

- 8.1 graphics library settings

8.2 graphical parts selection

8.3 graphics settings and nesting parts

Chapter 9: diagnosis function

9.1 check the input/output interface

9.2 check output

9.3 check input

The tenth chapter: system input/output interface connection

10.1 input principle

10.2 the system output principle

10.3 input port definitions

10.4 output port definitions

10.5 motor port definitions

10.6 (SF - HC30) DB15 core joint pin definition

10.7 wireless hand control (DB15) connection definition

10.8 RS232(DB9) connect definition

Appendix 1: SF-RF056 wireless hand control box

Appendix 2: instructions for SF-2100C-AH upgrade software

Appendix 3: installation dimension figure

Appendix 4: common troubleshooting

Chapter 1 System function interview

1.1 system function

SF-2100C-AH is applicable for kinds of flame/plasma cutting machine CNC system, widely used in small desktop cutting machine of metal processing, advertisement, stone material industry, etc.

The system is designed with high reliability, with plasma interference, lightning protection and surge capacity.

Practical flame/plasma cutting process, plasma processing, automatic corner speed control, and control the block.

Can use wireless remote control or wired control box to realize remote operation.

Slottting compensation function and test procedure of compensation is reasonable, the report accordingly, for the user to choose from.

Breakpoints recovery, can automatic power to restore function, also can be breakpoint memory automatically.

Function of any passage and punch point processing, can be arbitrary line escapement in machining.

Suitable for thick plate extension perforation function, and is suitable for the bypass function sheet.

Back, passage and breakpoints in recovery, to choose the function such as perforation position, greatly convenient user manipulation.

Can transfer cutting at any time, choose the starting point of processing. This can be automatically generated broken bridge.

Small segment of the special processing functions, walking is fluent, can be widely used in metal and advertisements, wrought iron, etc.

Including 24 kinds of graphics component library (customizable), contains the common basic processing parts.

With STARCAM nesting software is fully compatible with, and at the same time compatible IBE (Germany), FASTCAM in major nesting software.

Interface conversion, in both English and Chinese language. Also can be customized to other countries.

Dynamic graphical display, 1 ~ 8 times of graphics zoom. Fixed pointscan automatic tracking.

Using U disk read and software upgrades in a timely manner.

1.2 technical indicators

Processor: using industrial-grade ARM processing chip.

Display: 7 inches color LCD display, 800 * 480 resolution.

Input/output: the system to provide the number 13 photoelectric isolation input, 8-way photoelectric isolation output, including four roads relay output.

Linkage axle count: 2 axles, it can be extended to 3 axles linkage.

Top speed: < 24Meters/Min.

Pulse equivalent: flexible adjustment.

Storage space: 4G super user program storage capacity, processing program is not restricted.

Case size: 298 * 202 * 95.2 (mm).

Working temperature: 0 °C ~ + 40 °C. Storage temperature: - 30 °C ~ + 60 °C.

1.3 the company's products supporting application of CNC cutting machine



Chapter 2 System main menu

2.1 Menu characteristics

According to operating of the system, adopt function window prompt way step by step. Under the main window menu, after a function call, system will launch this feature of the child window menu. According to the prompt of screen window, press [F1] to [F7] key on the panel to choose corresponding function. Press "ESC" to return to the next high levels menu.



2.2 the main menu shows

The version number: the lower left corner tip is currently about software, hardware version information. Photos are for reference only.

[F1] automatically: automatic process control

[F2] manual: manual adjusting cutting gun position

[F3] edit: edit/modify/USB input/USB output processing program

[F4] parameters: the system parameter settings

[F5] diagnosis: check the machine input and output information

[F6] graphics library: standard graphics Settings and discharge

[G] [G] [3] setting: in the following dialog:



Among them

File format: formatting user space program

Initialization parameters: restore before delivery preferences.

ENGLISH: switch in both Chinese and ENGLISH.

Chapter 3 automatic function

In the system work under the main menu, press [F1] into the function of automatic main picture:

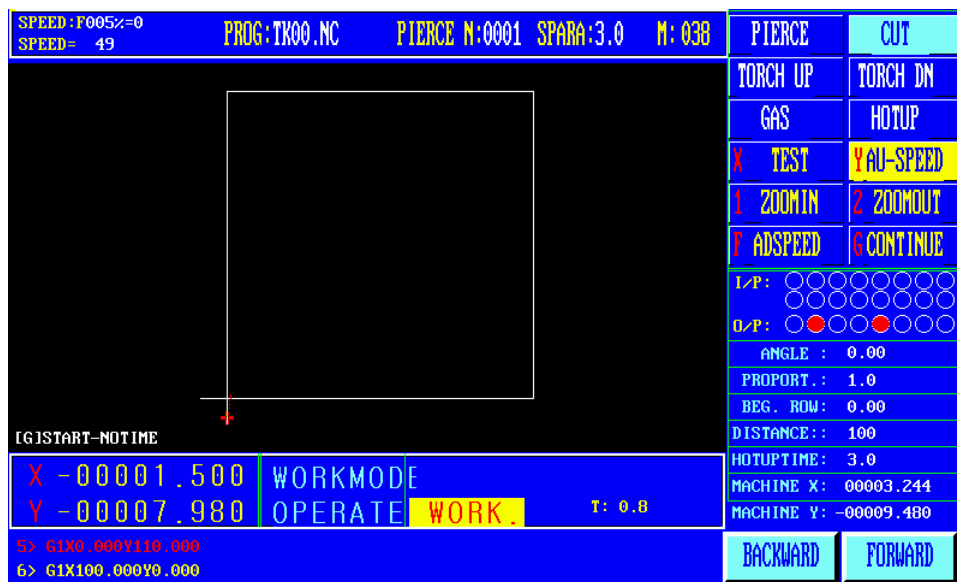

3.1 interface automatic way specification

3.1.1 speed

In automatic mode: left upper corner of the screen shows F * (automatic processing speed ratio value) = set value processing speed.

In manual mode: left upper corner of the screen shows F * (manual speed ratio value) = manual speed.

SPEED is the speed of the actual value, use **【F ↑】**, **【F ↓】** ratio value to adjust the current speed.

Press [F] speed setting directly on the screen, and press [enter] to confirm.

Note: the speed of the display value may be metric also can be inch, depends on the parameter settings in metric/inch option (see parameters - control).

3.1.2 procedure, perforated serial number, slotted

Respectively show the program name for processing program, the current has been perforated serial number (to be automatic processing automatically when the clearance), the current compensation slot width.

3.1.3 working mode, the operation information

Work mode bar shows: the current work status, such as choosing rotating,

breakpoints recovery, the mirror function, parts processing, etc. Operational information bar is displayed in: machining or suspended, various limit alarm, and delay time and other information.

3.1.4 input and output

Under the switch side, two platoon x 8○ "(when the parameter" to take over control box selection "is valid for three rows of x 8○).

The above said eight input port status, ○ says no signal input, ● said signal input.

Intermediate said 8 input port status, ○ says no signal input, ● said signal input.

Below said 8 output port status, ○ says no signal output, ● said signal output.

Input/output port definition is to see system diagnostic function.

3.1.5 machining parameters showed

The column shows the current various parameter values.

3.1.6 coordinate unit selection

Coordinate display may be a metric (mm) can also be inch (inches), depending on the parameter settings in metric/inch selection (see parameters - control).

3.1.7 according to a panel of six heavy current key, can control the

external heavy current, including:

[Ignition] Ignition function sees M20

[Preheat oxygen] opened oxygen solenoid valve, concrete M24

[Acetylene open] opened acetylene gas solenoid valve, concrete M10

[Cutting oxygen] opened cutting oxygen solenoid valve, concrete M12, plasma cases through arc starting switch

[Punch] high voltage control keys

Complete a piercing process, specific operation is as follows: Flame processing - the first cutting torch rises (M72), open cutting oxygen (M12), cutting down (M73).

Plasma processing - execute M07 instructions

[Skill] this is a very important function, in the later suspended is used repeatedly, the fallback, epitaxial perforation, when after the preheating, press "punch" directly, can make the punch starts with one.

[Always shut] close all high voltage output.

【 S ↑ 】 press cutting up, lift the stop.

【 S ↓ 】 press cutting down, lift the stop.

3.1.8 [1] enlarge figure

Press one graph 1 x magnification. Press 3 times in a row, graphic maximum amplification eight times;

3.1.9 [2] to restore

Reconstruction to the standard image size

3.1.10 [X] empty running

Press "X" button, the system for processing speed limit to run the program, but does not perform M instructions. This feature is used to quickly locate, or check the steel plate processing. May at any time in the operation of the suspension, and then press "X" key to cancel empty running.

3.1.11 [Y] speedprocessing

Speed system in manual and automatic speed is separated, push down this button (highlighted), adjust the speed for automatic processing in the process of speed ratio, vice to manually adjust the speed ratio.

3.2 the function option of automatic processing

Processing program can be transferred to file by editing function, if the program has been transferred to (same as long as the program name), can be directly run. If is to use U disk transfer into the program, especially large program, you cannot for storage, with the U disk processing run directly.

3.2.1 [F1] punch points

Specified from starting the random program (or perforation) arbitrary processing. Commonly used in the need to start from the application of a certain period of processing, or only used when processing a part of. Specific see passage function.

3.2.2 [F2] manual

System turns to the manual work mode.

3.2.3 [F3] find breakpoint

Select this function, press "start" button to start implement breakpoints recovery function, specific see breakpoint recovery feature.

3.2.4 [F4] graphics

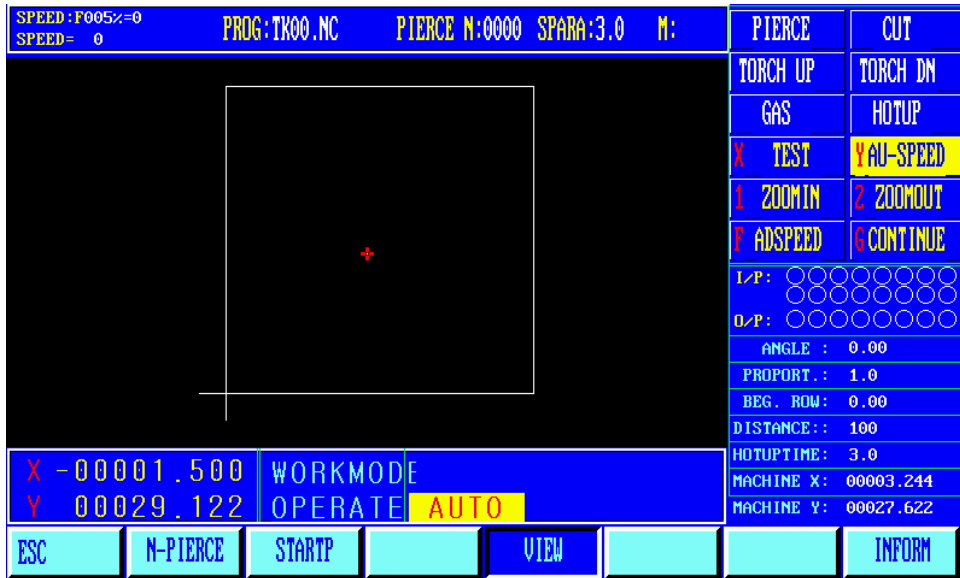

Select this function, the system display graphics processing procedure, and marking punch points are numbered sequentially, graphics origin points have cross cursor. Press [1] 1 time magnification graphics (up to three times, enlarge 8 times), press [2] graphics recovery, according to the **【 ↑ 】【 ↓ 】【 ← 】【 → 】【** key mobile graphics display position.

3.2.5 [F5] set slot

Click this button prompts for slot width compensation, if you don't compensate (usually in the nesting compensation) can enter 0.

3.2.6 [F6] auxiliary function

Press [F6] key to enter the next level menu, shown in figure , the following:

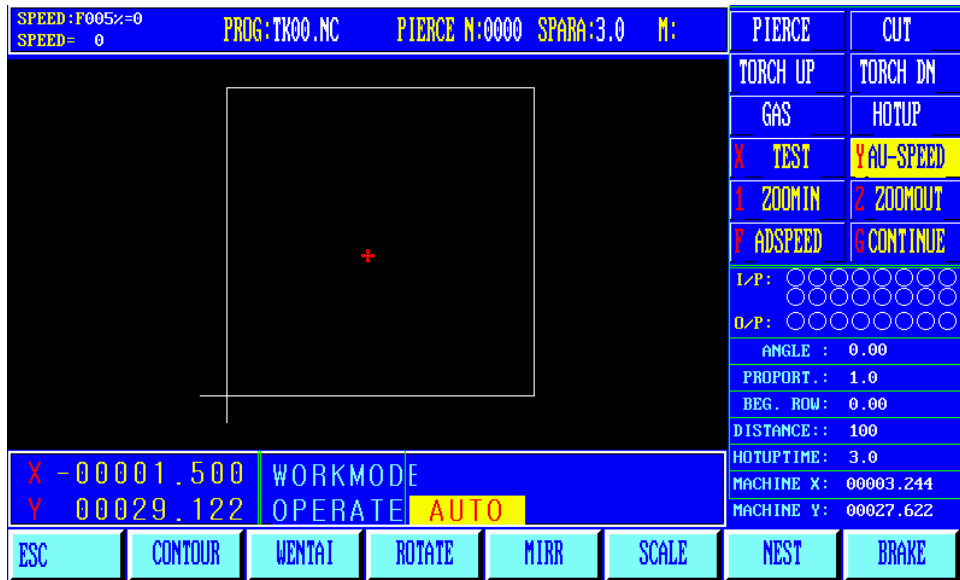

3.2.7 [F1] contour line function

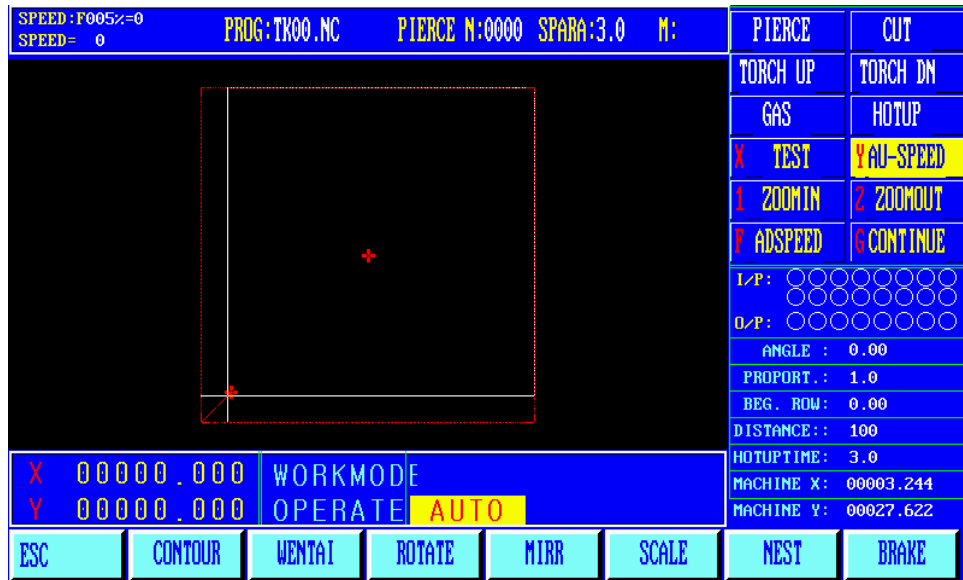

The user before processing, can be determined by taking the contour line, the machining path is beyond the scope of the steel sheet.

Press [F1] key to start walking contours, if not on the current torch reference point (coordinates not zero), the system will prompt:

The current point positioning --- will torch the current position as a reference point. Reference point location --- torch to return to the reference point, and then began to walk contour.

When walking contours, if the torch over the range of steel, according to the [Pause] key to move the position of the torch to the plate edge, then press [Start] button, then the system prompt: Modify the reference point "EN / ESC?" Press Enter to confirm the reference point if changed, the current location will continue to operate as a contour line. Press [ESC] to abandon changes. This operation can be repeated many times do run until the position you prefer.

3.2.8 [F2] WENTAI

Press [F2] button, the system prompt processing WENTAI program, WENTAI is a word processing of CAD/CAM software, cutting of calligraphy in the advertising industry process, there are a wide range of applications. If processing WENTAI generated program, need to choose this functionality.

3.2.9 [F3] rotation (steel plate correction function)

3.2.9.1 rotation angle processing

Processing steel plate lifting is impossible once, or for other reasons need to rotate an angle processing, can choose the function. Can cooperate [manual] - [supplementary] - [starting point measurement] and [measuring the finish] using rotating function. Also can be directly input Angle. After confirmation, the system will reduce the machining procedures according to the specified Angle rotation. Note: a positive perspective to counterclockwise.

3.2.9.2 example:

By measuring the an edge of the plate (a line) as the starting point and end point, calculation of rotation Angle, as follows (the following is done in the manual - auxiliary mode):

First determine baseline, take a plate from the sidelines do baseline, move the cutting torch to baseline starting point, press [F3] set the starting point.

Control cutting along the baseline to the end (starting point and end point more far more accurate), cutting gun aimed at baseline, press [F4] set the end point.

When relative to baseline rotation Angle are calculated automatically, complete rotation function, rotation Angle display in operation information bar.

3.2.10 [F4] mirror

Continuous press [F4] mirror respectively select X, Y, mirror, cancel the mirror.

Choosing X mirror, along the X direction of axisymmetric process execution, looks like a turnover on the up and down.

Choosing Y mirror, along the Y direction of the axisymmetric execution process, looks like a turnover.

3.2.11 [F5] proportional

Press this key system prompts for scaling, system application, enlarged or reduced according to the proportion, this feature is useful to hand art by in the process of cutting.

3.2.12 [F6] discharge function

For a single process that has programmed, can through this function arrangement processing.

System prompt:

Arrangement of rows - Y direction to arrange the number of rows Arrange the number of columns - the column number of the X direction is arranged.

Line spacing - spacing between the X direction of the workpieces. The gap between the column spacing - Y direction of the work pieces

Line offset - the even lines, migration distance to the right.

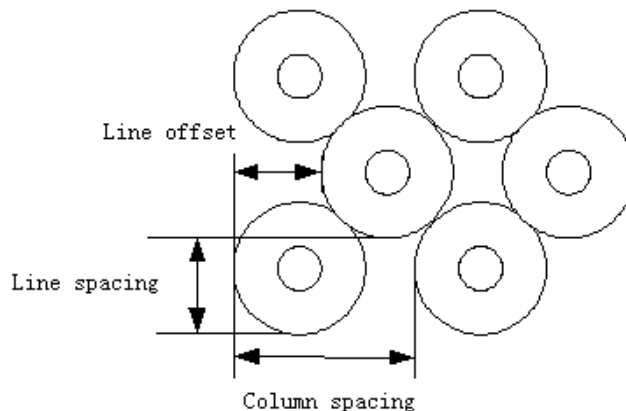

3.2.13 broken bridge function

Choose this feature, during processing, every cutting length (broken bridge point. Mm. See [parameter] the [control]), will set up a bridge cut-off point, partition bridge length (MM) (see [parameter] the [control]) controlled by the operator to continue after cutting. Note: this function has remained until then click this button to cancel the function.

3.3 automatic startup

3.3.1 cutting speed

When machining, the automatic speed ratio adjustment.

The speed of execution = machining speed limit * ratio, **【 F 】**, **【 F ↑ 】**, **【 F ↓ 】** is automatic rate adjustment. The two speed ratio once set, it is forever, is not affected by the shutdown.

3.3.2 automatic machining start

1) Before automatic machining start

To choose the correct processing program, select the appropriate processing rate (ratio), the cutting torch on the cutting height (after the start process, automatically cutting torch lift (execution M70)), and other preparations in place, can start the process automatically.

2) There are two ways of automatic processing start:

According to the green "start" button on the panel.

According to external "start" button (see "input and output port definitions")

3.4 adjustment of cutting position of automatic control

3.4.1 track in the process of automatic processing begins, only the

following keystrokes effective:

[Pause]: press this button, the system movement slowing down to stop, close cutting oxygen (plasma processing, shut off the ignition switch), closed higher controller (M39), keep the currently displayed image. If you choose in the parameter is set to "suspended after raise gun (1)" (see control parameters), suspended after cutting torch will lift (M70).

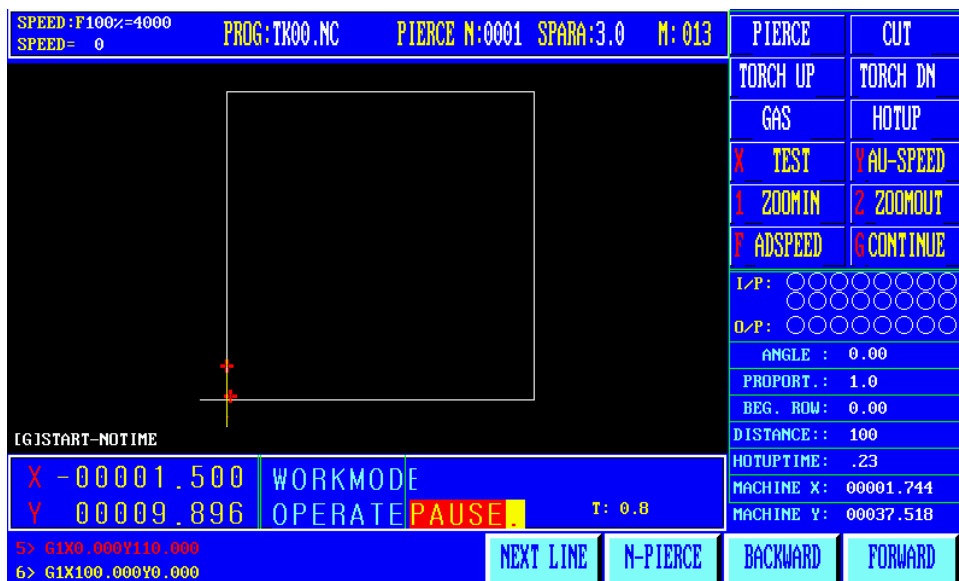

After suspended can be the following:

- a) Select new piercing point, press "F5" key to enter the new perforation after a period, the system automatically go to the new perforation, waiting for the punch operation.
- b) The original track back.
- c) Press "F4" button, select the line escapement operation, the system prompt: fallback, forward and choose program line, according to mark new selected row cursor position operation, press the "start" key, the machine go to the new line escapement position, waiting for the punch instruction to continue processing.
- d) Adjust the position and so on.
- e) Exit processing.
- f) [Start]button: systems continue to run.
- g) [ESC] key: Exit the machining program, return to the automatic image.
- h) 【F ↑】, 【F ↓】 speed adjusting button: increase or decrease feed speed ratio.
- i) 【S ↑】, 【S ↓】 control cutting torch up and down. Press the corresponding key, cutting up or down. Raise my hand cutting movement to stop.
- j) [Stop key]: Scram button for external key (see the [external input interface]), the signal from the input port access. When stop is valid, and stop all movement, output shut down, for unexpected emergencies. Due to the conditions of the suspension system and the following points:
 - 1) The external pause button press.
 - 2) Plasma processing, and choose the "arc pressure test (1)", if the broken arc will be suspended.
 - 3) If you choose "" bump shot detection (1)", efficiently gun will be suspended.

3.4.2Pause after the adjustment of position of the cutting

3.4.2.1 the following several ways of cutting torch position need to

adjust:

- 1) Cutting torch is blocked, or need to change, often move the cutting torch to a safe location, after processing to return to the starting point.
- 2) Need outer perforation, don't want to put the punch points on the outer limits of the machining. In the workpiece outside to look for a suitable position (usually the edges of the plate), perforation and then cut along a straight line to the starting point (pause) continue to normal processing.
- 3) Transfer of cut, work piece is bigger, wide is bigger, need to change the local cutting.

3.4.2.2 several operating can adjust the cutting position of the

following:

- (1) Suspension
- (2) The fallback
- (3) Punch
- (4) Parts processing
- (5) Machining
- (6) Breakpoint recovery

In the state, if want to change the cutting position, can be directly according to the **【↑】【↓】【←】【→】** key to adjust the position of the cutting torch (the system ratio for manual rate can be adjusted). After adjustment in place, press the [start] key, the following dialog:

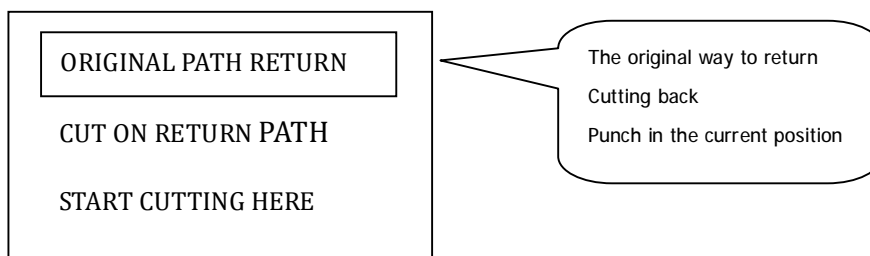

1) Return to the original road

To return to adjust starting point with the speed of G00, in this waiting for further operations. At this point according to the corresponding high voltage function keys (such as ignition, preheated perforation, open cutting operations such as oxygen). Suggestion: after preheating, and then press [punch] key, then the system starting from the breakpoint position to continue processing.

2) Cutting back

First perforation, again with cutting speed along a straight line from the current position to adjust the starting point, don't stop according to the original path to continue processing, a bit like epitaxial perforation, perforation point more smooth.

3) Current perforation

Perforation first, to adjust the current coordinates to suspend the coordinates, according to the original path to continue processing, in order to realize the transfer function of perforation.

4) Note: before operation 2) and 3), should be fully preheat (fire), because once chose operation, punch right away. Normal practice should be first preheating (fire), then to press the [start] key.

3.5 the original track back processing

For failing to cut through, in the processing to the original track back, is as follows:

3.5.1 Track of the original track back, press **【pause】**, slow down the running system, the system displays "pause" tag, and presented the following figure.

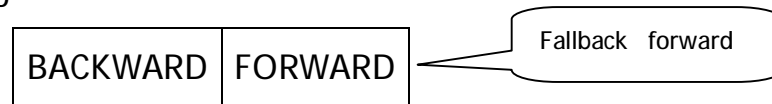

Press "F6" key system to perform the original track back, back speed set in the parameter - speed - back.

Press the "F7" key at the back, on the basis of the original trajectory. In the process of back, if do not meet the need of position, can press the **【pause】** again, repeat the above process, until a bit.

3.5.2 encounter G00 (reach a piercing point) back in the process.

When back, meets G00 (reach a piercing point) suspended system, the operator can choose is to continue to back, or forward.

3.5.3 back to operations

Back to the designated place, can choose cutting torch position adjustment, (see 3.4), may also directly bring a perforation, according to the corresponding high voltage function keys (such as preheating perforation, open cutting operations such as oxygen). Typically:

Good for preheat, then press "punch", in the case of fire, burning torch, oxygen cutting, cutting down, the system to continue running, under the condition of plasma arc open, wait for after the arc, the system to continue running.

3.5.4 Above operation can be repeated, until get the desired effect.

3.5.5 exit processing state

Press "ESC", during a break in system processing status.

3.5.6 fallback procedure of the total number of rows and the starting

line Fallback procedures section, most within the 300 lines, if it is a breakpoint recovery, or parts of the processing, the back of the starting line is the current breakpoint or passage, not on the basis of rolling back processing.

3.6 breakpoint recovery and double breakpoints recovery processing

3.6.1. Breakpoints recovery

- 1) In the system for suspension or for processing power failure, the system will automatically save the current cutting torch position for a breakpoint. The breakpoint will be permanent, whether to turn it off or not.
- 2) When in automatic mode, as long as the current program did not change, can press "F3" find the breakpoint function, then press "start" button, system breakpoint began to recover.
- 3) If the cutting position has not changed, then find the breakpoint, prompted to "break", waiting for the next step. User can choose directly **【perforated】** cutting position adjustment, see 3.10.
- 4) If the cutting position have changed (not on the breakpoint), after the system find the breakpoint, can appear the following three options (The fact is the cutting position adjustment).

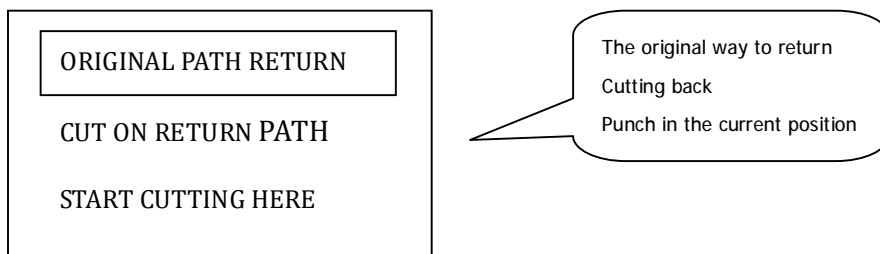

The original road return -- to return to the breakpoint with the speed G00, commonly used in general (exchange) cutting set breakpoints.
 Cutting back -- a breakpoint recovery can be slightly left point breakpoints, a bit like the outer perforated, make breakpoints more smooth;
 Current punch -- like the previous operation, transfer can also be used to cut with.
 At this point according to the corresponding high voltage function keys (such as ignition, preheated perforation, open cutting operations such as oxygen).
 Tips: After preheating, then press "punch", then the system starting from the breakpoint position to continue processing. When it finds a breakpoint, press "ESC" key, system exits the processing status.

3.6.2 double breakpoints recovery feature

System can save two procedures that face the breakpoint. Operators do a larger

program A, the intermediate temporary stop (generated the first breakpoint), to do another program of B. After the call the program A again, can be directly do restore (【find the breakpoint 】) breakpoint, the system will automatically find the location of the interrupt for the first time, to continue processing.

3.6.3 note:

Both breakpoints recovery and restore power, are not allowed to change the Angle of rotation, scaling, the condition of the system will automatically save, not affected by the switch machine. Otherwise the system may find the breakpoint.

3.7 parts of choose

3.7.1 start the parts choose

Parts of functions specify system, from the program (point) or a perforation arbitrary start processing.

3.7.2 select parts processing there are generally two kinds of situations:

3.7.2.1 transfer processing. It starts from a certain position in the program, in a place to start processing.

3.7.2.2 will start a paragraph from the program after program to processing it again.

- 1) For the former, usually find a piece of waste, on the punch point directly processing (optional, the current point positioning).
- 2) In the latter case, the orientation from the reference point (optional, reference point positioning).
- 3) For the two options, the system that after the boot prompt (below):

A) If you select "current point positioning", after the system is running, the first map, and on to the position of the punch, draw a big cross cursor, the operator can press [S] graphics to enlarge, to see whether to need to punch positions, if not satisfied, can press "ESC" to exit the processing state, select again.

B) If the requirements of the perforation point, can be controlled by high voltage

switch, ignition, preheating, press "punch" up and running;

C) If you select the "reference point" to start, the operator should aim the cutting torch reference point. After start-up, the system control cutting punch point and the rest of the operating methods.

3.8 the edge of the thick plate perforation

1) Automatic processing of the thick plate processing method should be used when perforation.

2) Edge of the perforation of the method is: Before punch cutting torch to move to the edge of the plate recently.

3) Start preheating, when after the preheating, press the "start" key, cutting along a line distance and the selected cutting speed cutting to punch, cutting processing again.

4) Uses the edge notch, the first change parameter control menu of edge notch choice to 1 (said to choose effective). So every hole, the first prompted the diagram below:

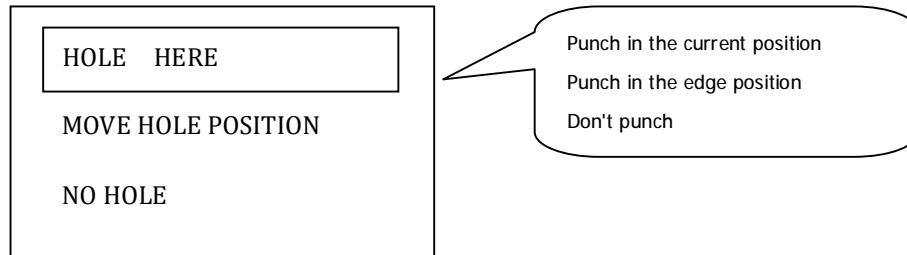

3.8.1 select perforation the current position

Perforation system the original position, commonly used hole.

3.8.2 perforation the selected edge

(1) The operator may according to the selected [up] [down] [left] [right] key, adjust the position of the cutting torch to the outer limits of the steel plate (the speed ratio automatic adjustment for 5%), start preheating.

2) When the preheating ended, press the "start" key, cutting along a line distance and the selected cutting speed to punch, cutting processing again.

3.8.3 choose don't punch

Don not punch, the system runs directly from the current perforation position. Blank line to the next hole, a new perforation tips.

The fourth chapter Manual function

System work under the main menu, press "F2" button to enter manual function, as shown in the figure below:

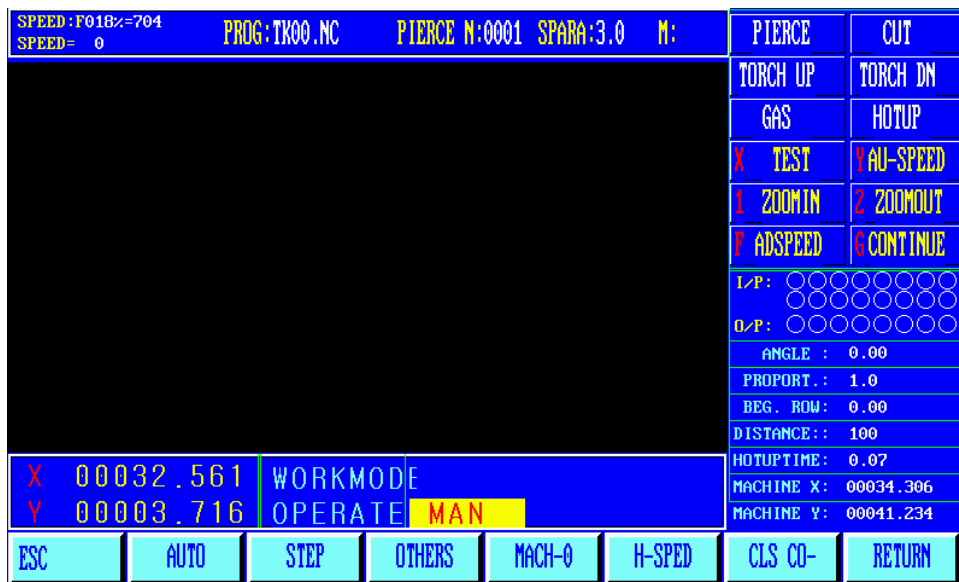

4.1 manually interface manually interface display with automatic mode.

Difference in the value of the ratio of the manual, it affects the manual operation, back to the speed, movement speed, etc. Directly on the screen press [F] speed can be set. There are some special operation manual modes.

4.1.1 [up] [down] [left] [right] the direction control keys and [G]

continuous walk normally, press the four direction key, the corresponding axial movement, raised my hand against the stop. But according to [G] choose walking straight (highlighted), press the direction key cutting start (Raise hand stop), press the stop again. If need two axis at the same time, can walk on a shaft, another axis of the direction key, press the two axis movement at the same time. Press any key direction at this time will stop cutting torch corresponding axis, and the rest of the shaft to continue walking, walking until then press the axis direction, movement stops. [Pause] button will also stop movement.

4.1.2 "F1" automatically

System into automatic working mode

4.1.3 【F2】 inching

Press "F2" button, click on, appear some dynamic incremental selection dialog.

Point move incremental there are four choices:

The first three are commonly used incremental. Finally a press 3 - input increment is

manual input increment. In inching mode, press a key direction, cutting at the speed of the current highest speed limit by ratio, run a point incremental value.

4.1.5 [F3] high speed

Quick select manual ratio, press F5 high-speed (highlighted) ratio is 80%, then 10% at low speed.

4.1.6 "F4" clean coordinates

Quickly reset X/Y values.

4.1.7 speed at the upper left screen display F * (manual speed ratio value) = manual speed. Directly on the screen press [F] speed setting, and press "enter" to confirm.

4.1.8 "F8" auxiliary

Login into the auxiliary functions, the system shows the following interface.

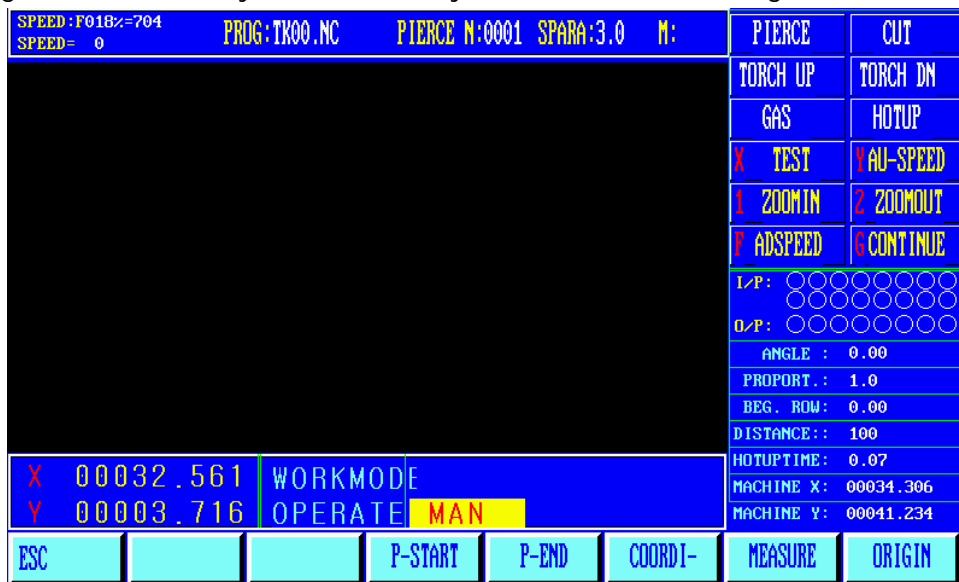

4.1.9 [F3] starting point, "F4" measuring the finish line, steel sheet processing calibration function

Steel sheet is impossible once, assembly, or for other reasons need to rotate an Angle processing, the choice of this function. Will be cutting down the side of steel plate in a straight line (as long as possible) to choose two dots ([F3] test starting point and end point "F4" test). The system will automatically calculate the rotation angle. To choose of the rotation function of the automatic processing input angle. After confirmation, the system will reduce the machining procedures according to the specified angle rotation.

Note: a positive perspective to counterclockwise.

4.1.10 "F5" set coordinates

There are three options: click this button reset all coordinates, set the current coordinates, it is set to the reference point coordinates.

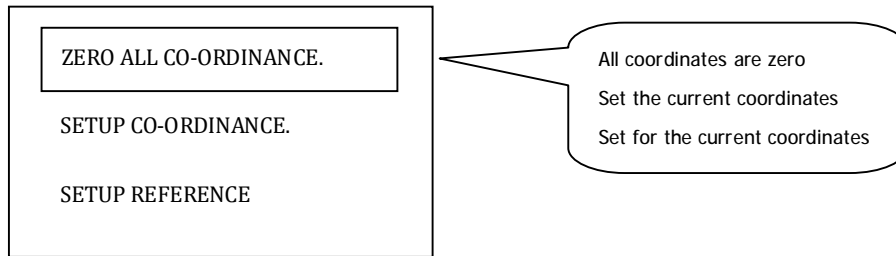

4.1.11 "F6" origin and "F7" reset

Machine back to the origin can be divided into "measuring the origin" and "reset" two parts.

Machine back to the origin, is the process of return machine mechanical zero point, back to zero biaxial running at the same time, independently back to zero. Reset (before back to zero):

(a) Mechanical origin should choose NPN hall proximity switch (normally open, the signal is low), and install in a suitable position.

(b) Set parameters (see parameter F3) reset speed - see "parameters" - "speed", reset when the feed rate, the unit is mm/min. reset direction - see [parameter] - [system], 0 - the shaft no longer, 1 - reverse, 1 - positive.

(c) Machine back to zero point process is as follows:

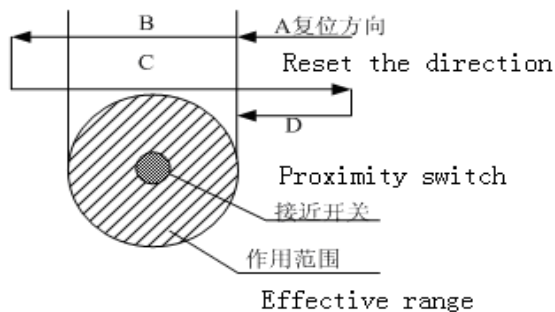

Section A: to reset speed fast forward.
Section B: slow down stop
Section C: reverse crawling to the effective area.
Section D: forward, to stop the valid area (the end).

(d) To measure the origin, to determine the mechanical origin of the work piece coordinate system. Methods:

Cutting torch will be moved to the reference point in the work piece coordinate system (a bit). set the current work piece coordinates.

[manual] - [supplementary] - [origin] measurement system to complete the mechanical origin, and the current coordinate values into the origin of the machine tool value, parameter Settings 【system】 option in the origin of the machine tool change accordingly.

(e) Reset - cutting back mechanical zero, and set up the work piece coordinate

system.

Method: [manual] (or [automatic]) – auxiliary – reset, origin system to complete the mechanical action, and the origin of the machine tool is set to the current coordinates of the machine tool coordinate set to 0.

【note】 : If two axles in the parameter reset direction from 0, namely no reset action, execute reset after operation, the current value is equal to the origin of the machine tool. Machine tool coordinate is equal to zero, this is important, because the program limit is machine tool coordinate as a benchmark. Cutting torch will be moved to the first mechanical origin (the origin is not necessarily true), select reset function, can determine the current machine tool coordinate (zero), then according to the distance from the effective on both sides of the mechanical origin, fill out the positive/negative limit value of the software.

Chapter 5 editing function

In the system under the main menu, press "F2" to enter editing menu, as shown in the figure below:

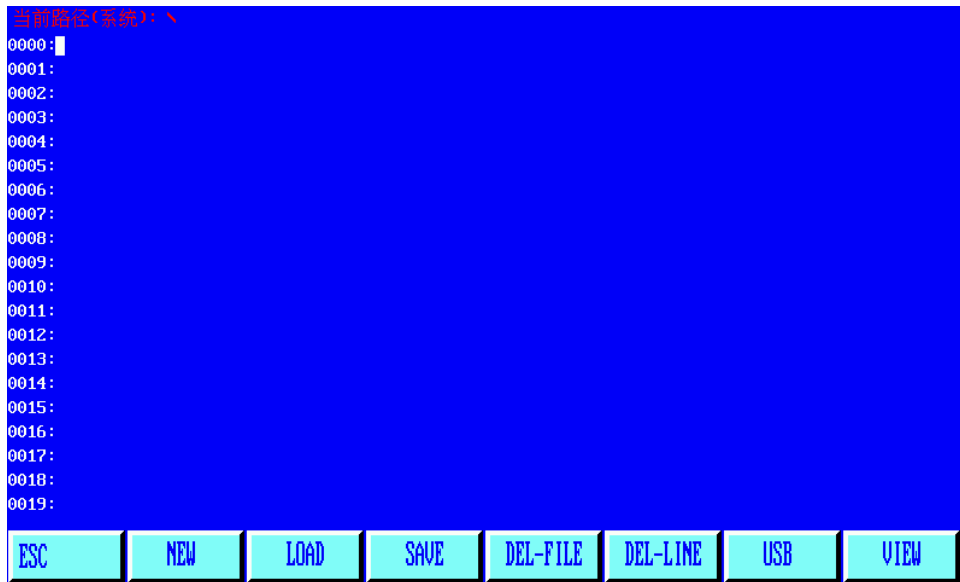

5.1, editing menu description

5.1.1 [F1] build

To build a new program, the clearance process editor area, and start editing a new processing procedure.

5.1.2 [F2] call in

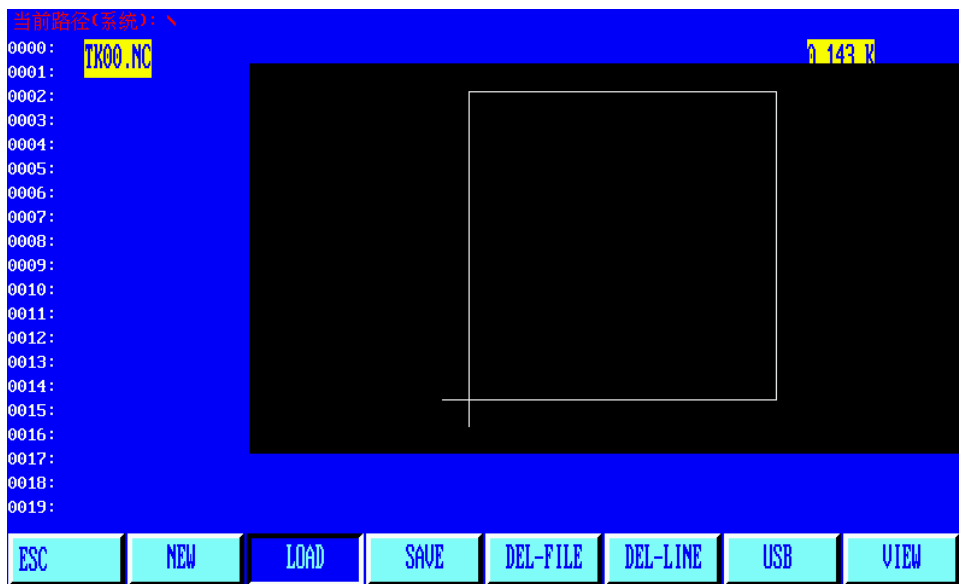

Transfer into the program, select the call in the user program in the program, the system will be an existing program, displayed in a tabular form, and the cursor stays on the program name. Move the cursor keys to select different programs. After press enter, the selected program loading process editor area. If you press "F7", graphic displays of the program. Press "ESC" to give up to function.

5.1.3 [F3] storage

Stored program, editing procedures for storage, the system hint: enter the program name: 1234.TXT

System shows the current program name, can be modified. If press the return key, to edit the program, to select the name of the deposited in the program area, if press the "ESC" key is stored program.

Note: the program name and extension shall not exceed 12 characters.

5.1.4 [F4] delete files

Choice of to delete user program in the program.

5.1.5 [F5] delete line

When program to edit out the entire line, increase the speed of editing.

5.1.6 [F6] USB

Transmission procedure, the system supports USB transfer procedures. After press "F6" key to enter the next level menu below:

| | | |
|-----|-------------|--------------|
| ESC | INPUT F1 | OUTPUT F2 |
|-----|-------------|--------------|

[F1] input To send U disk program to the system process area.

[F2] output After the system processes program, output to the U disk in the program area.

5.1.7 [F7] graphics

When you want to preview the currently selected program file processing by the graphics, can press F7 key.

Chapter 6 instruction system

6.1 programming symbol shows

That action of every step of numerical control processing, is carried out according to the prescribed procedures, each process is composed of several instruction period, each instruction, and consists of several functional characters, function of each word has to be made by letter, followed by the parameter values.

Function word definition:

| | |
|---|--|
| N | instruction period of serial number |
| G | preparation |
| M | auxiliary |
| T | tool functions (in this system refers to the flame width) |
| L | cycles, delay time |
| X | X axle (diameter) absolute coordinates |
| Y | Y axle absolute coordinates |
| I | arc processing, center coordinate values minus the X axle starting point value |
| J | arc processing, center coordinate values minus Y starting point value |
| R | arc radius specified |
| H | high arc string specified |
| A | secondary variable |
| F | processing speed, used for G01, G02, G03. |

Note 1: in the introduction to the following, have agreed as follows:

X [U] n, signs X or U, n is a number, but one can only appear. By the same token, the Y [V] n - can be Y or V, n is a numeric value, also can appear one. PPn - said combination can be any axis, containing at least one axis, also can contain two axes.

Note 2: instruction execution order, and the execution of a program in the program before the next. Within the same program instructions is before G M, S, T.

6.2 coordinate system

The numerical control system adopts standard rectangular coordinate system, the following figure:

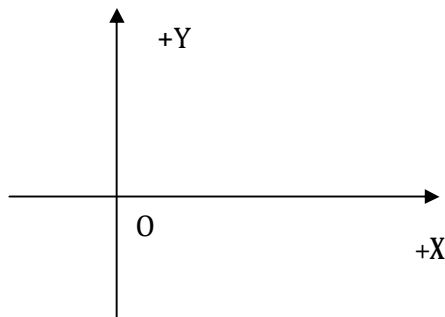

6.3 G (Basic preparation instructions)

(1) G92 reference point setting

Set program is running, processing starting point (reference point) coordinates, must start in the program, and set the absolute coordinates.

Format: G92 XnYn

If not after G92 with X, Y, with the current X, Y coordinates of reference points. In commonly when used machine tool positioning, G92 not with X, Z content.

2) G90 / G91

G90 absolute coordinate system (default)/G91 Relative coordinate system

When using G90, X, Y coordinates, U, V relative amounts of the current point. When using G91, X, Y, and U, V are relative to the current point relative amounts.

Format: G90

Format: G91

Example 1:

G92 X0Y0

G91 // relative coordinates

G00 X100Y100 // quick positioning to (100,100), quite G00 U100V100

G01 X500Y100 // linear processing to the position (600,200), quite G01 U500V100

Example 2: G92 X0Y0

G90 // absolute coordinate system, but the default

G00 X100Y100 // quick positioning to (100,100)

G01 X600Y200 // linear processing to (600,200)

3) G20 / G21 imperial/metric shows

G20 imperial explains, the G20 after the X, Y, I, J, R, U, V, H, F, all are English unit.

G21 metric specification (the default), G21 after X, Y, I, J, R, U, V, H, F, are all metric units.

Format: the G20

Format: G21

1) G00 point exercise

This directive can be realized fast feed to the specified location. When two axes have a displacement system use the highest speed ratio, linear motion from start to finish. When G00 movements, was influenced by speed ratio. Format: G00 X [U] n Y [V] n

Or: Y G00 P Pn.

Ex: G92 X0 Y0
 G00 X120 Y280
 (Or G00 U120 V280)
 M02

- The current position
- The target position

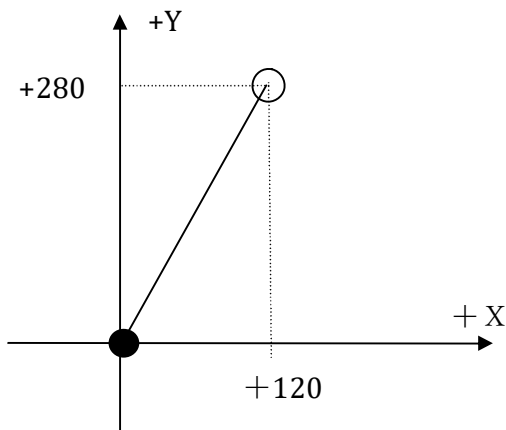

2) G01 linear cutting

This directive can realize tool linear feed to the specified location, as cutting movement instruction, can be single axis or two axes linear interpolation motion. Feeding speed can be specified by F command.

Format: G01 X [U] n Z [W] n [Fn]

Or: G01 PPn (Fn)

EG: G92 X0 Y0
 G00 X200 Y95
 G01 X80 Y235
 (OR G01 U-120 V145)
 M02

- The current position
- The target position

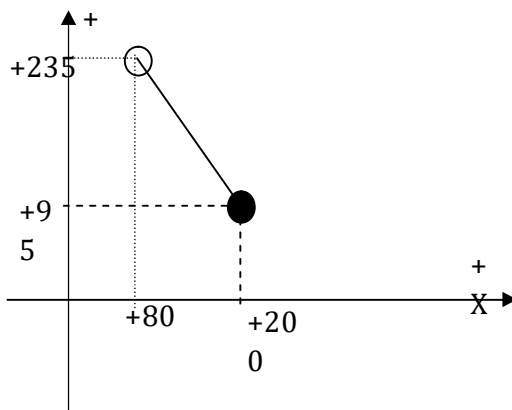

3) G02 / G03 arc cutting

This instruction is applied to circular arc interpolation. Instructions are divided into smooth arc G02 (clockwise), inverse arc G03 (counterclockwise). Good or poor in the direction of the Settings below:

Format: G02 [03] X [U] n Y [V] n In JN [Fn]. Or : G02 [03] X [U] n Y [V] n Rn (Fn)
 G02 [3] PPn In Kn (Fn). Or: G02 [03] PPnRn [Fn]

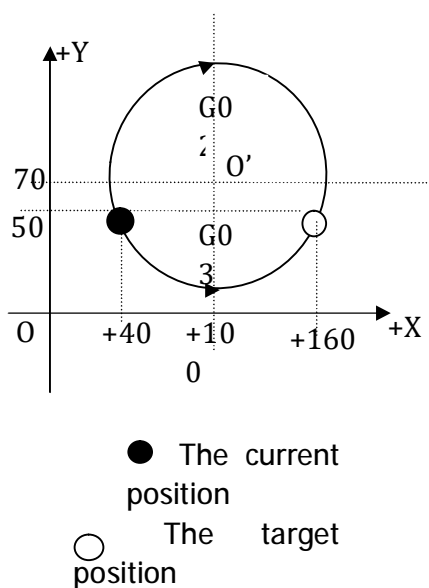

```

EG(G02):
G92 X0 Y0
G00 X40 Y50
G02 X160 V0 I60 J20
G28
M02EG ( G03 ) :
G92 X0 Y0
G00 X40 Y50
G03 X160 V0 I60 J20
( Or G03 X160 V0 R63.25 )
G28
M02

```

Description:

I and J are for the X, Y axes relative to the starting point of the incremental value of circle center (starting point).

R is for round radius (R positive, when arc 180 ° or less can be used to describe the radius R). If specified I, J, R. If R, don't use I, J.

4) G04 pause/delay orders

This directive is used to set the time delay, when the program execution to this directive, the program according to the L time delay, in seconds.

Format: G04 Ln

Example: G04 L2.4 (2.4 seconds delay)

During the period of execution of G04, press the "start" key is terminated latency, continue to implement G04 after application, press "exit" key to terminate the current execution.

5) G26, G27, G28 return reference point

This directive tool can be realized automatically return reference point.

Format:

G26 X returns to the reference point

G27 Y returns to the reference point

G28 X, Y axes at the same time to return to the reference point

Example: G28 (X, Y axis at the same time to return to the reference point, equivalent to go G00)

6) G22 / G80 loop statement

This directive can be used to execute a program cycle, G22 as the beginning of the loop body, and specify the cycle number L. G80 as end of the loop body mark, this directive can be nested loop, but not more than 5 layers. G22 with several recent G80 downward constitute a loop body.

Format:

G22 Ln (L designated cycle)

The loop body G80 (end of the loop body signs)

For example:

N000 G92 X100 Y100

N001 G00 X60 Y80

N002 G22 L5 - the first layer of circulation.

N003 G00 V50 U - 25

N004 G22 L5 - the second loop begins

N005 G01 U5 V - 10

N006 G80 - the second end of the cycle.

N007 G80 - the first layer loop ends.

N008 G28

N009 M02

7) Tool radius compensation statement (G40, G41, G42)

Format: G41 (or G42) Rn.

Need to compensation procedures section. G40

Note:

G41 is for the processing of path, the compensation to the left half of the flame diameter.

G42 is for the processing of path, the compensation to the right half of the flame diameter.

G40 is for end of migration.

Because of the cutting tool compensation is done automatically, so before G41, G42 instructions must be G00 rapid positioning statement, in order to make sure the cutting nozzle can adjust the position. After cancel the knife repairing G40, still need to have a G00 statement position to adjust back.

6.4 M auxiliary function

M00 pause command, suspend execution program, press the "start" key to continue.

M02 instruction program ends, after the execution process in the wait state M30 same as M02

M10 / M11 gas (acetylene) valve switch, M10 (open), M11 (close)

M12 / M13 cutting oxygen valve switch, M12 (open), M13 (off)

M14 / M15 cutting torch switch, M14 (open), M15 (off)

M16 / M17 cutting torch switch, M16 (open), M17 (closed)

M24 / M25 standby switch, M24 (open), M25 (closed)

M20 / M21 ignition switch, M20 (open), M21 (closed)

M07 fixed cycle perforation (after entering M07, not back, can move gun)

M08 concerns cut fixed cycle

Flame cutting operating sequence is as follows:

M07

1. If gas (acetylene) valve is not open, open (acetylene) gas ignition.
2. Cutting down (cutting down latency, see M71).
3. Preheat the oxygen valve, began to preheat time delay, if the preheating time is not enough, can press **【pause】**, preheating time delay automatically extend to 150 seconds, if preheating is good, can press the "start" button, the end of the preheating time delay, and will be automatically saved in the preheat time delay parameters.
4. The cutting torch rise (perforation cutting up delay, M72).
5. Open cutting oxygen valve (M12), delay time, delay perforation after cutting down (perforation cutting delay M73).
6. Open the block (M38). Then began to run after the program.

Plasma cutting operation sequence is as follows:

M07

1. Cutting down (cutting down latency, see M71).
2. If you choose to perforation orientation (see parameter Settings) effectively, the cutting down, until the lower limit position switch, stop falling. After cutting, delay in holes positioning, stop cutting torch.
3. Open the arc switch
4. Detect "success" arcing voltage signal, if the parameter settings in the arc pressure detection from 0 (no) is any arc pressure, after the success of the arc, delayed perforation delay (in seconds).
5. Open the block (M38), began to run after the program

M08 concerns cut

Flame cutting fixed cycle operating sequence is as follows:

1. The concerns cut oxygen (M13).
2. Shut down the block (M39).
3. The cutting torch rise (M70).

Plasma cutting operation sequence is as follows:

1. The arc pressure switch.
2. Shut down the block (M39).
3. The cutting torch rises (M70).

M50 perforation action:

1. The cutting torch rise (M72), plasma operation without the action.
2. Open cutting oxygen (M12). Or open plasma arc, the detection of "success" arcing voltage signal.
3. Cutting down (M73), plasma operation without the action.
4. Open the block (M38).

M52 ignition fixed cycle:

Operating sequence: open gas (acetylene) valve (M10), high voltage ignition (M20), delays the ignition delay time, high voltage ignition (M21).

M70 cutting up fixed cycle:

Use the program starts, and a cutting end of the program, to raise cutting torch, so that the cutting torch fast move to the next cutting position. Sequence of operation: open cutting up switch (M14), delay cutting up delay (see 7.3) flame parameters, cutting up switch (M15).

M71 cutting down fixed cycle:

Used in punch, role, in contrast to the M70, but slightly smaller, because of the effect of gravity, than to hurry up.

Sequence of operation: open cutting down switch (M16), delay cutting down delay (see 7.3) flame parameters, cutting down switch (M17).

M72 perforation cutting up cycle:

Use after preheating, to raise cutting co., LTD., to avoid pulling cutting oxygen, splash of steel slag to block the mouth of the burning torch.

Sequence of operation: open cutting up switch (M14), delayed perforation cutting up delay (see 7.3) flame parameters, cutting up switch (M15).

M73 perforation cutting down cycle:

Use after preheating, performed M72, open after cutting oxygen, the cutting torch on the cutting position, is M72's action, but slightly smaller, because of the effect of gravity, than to hurry up.

Sequence of operation: open cutting down switch (M16), delayed perforation cutting down delay (see 7.3) flame parameters, cutting down switch (M17).

M75 cutting torch orientation delay:

Plasma rob positioning, cutting down (M16) first, when met the lower bit (see input port 8 XXW), stop cutting down (M17). And the burning torch up then (M14), after cutting positioning delay (see 7.4) plasma parameters, later, stop cutting up (M15).

M62 line drawing function:

After performing M62, cutting from the current position, offset a line drawing gun offset (see parameters setting function of the system). Since statements are function of line drawing, till the M63. When painting line does not perform slotting compensation function.

M63 end of line drawing function:

After performing M63, end of line drawing function, cutting from the current location, returns an offset line drawing a gun.

M80 terminal shut:

After executing M80 all outlet will be closed.

Chapter 7 Parameter Settings

In the system work under the main menu, press "F4", enter the parameter Settings interface, as shown in the figure below:



7.1 Parametric Description:

Speed parameters

The axis starting speed, adjusting time, highest speed limit;

System parameters

The shaft electronic gear ratio, the origin, reference point, the reverse clearance, line drawing bias, soft limit of positive/negative.

Flame parameters

Flame ignition delay, preheating time delay, cutting torch rise/fall time delay, punch cutting torch ascending/descending, perforated delay, etc.

Parameters of plasma

Cutting torch orientation delay, arc starting with M instructions, arc breaking with M, the choice of arc pressure detection, position detection, perforated delay.

Control parameters

Include flame/plasma mode selection, processing speed, edge notch choice, metric/inch selection, etc.

Storage capabilities

Modified parameters will be stored in the area.

Note:

- 1) Selecting the above parameters, if the changes effective, needs to be stored separately, namely according to the "F8" storage.
- 2) Under the parameters of the main interface input password after "1928", "F8" save menu to factory Settings. At this point, the parameter changes will be stored in the factory Settings parameters, and the current user parameter. Upon initial parameters, the parameters are for the current factory. Otherwise, applies only to modify the current user parameters. After input password will pop-up menu, can choose to save the parameters to factory Settings **】【 U disk save parameters 】【 U disk import parameters 】【 any functional operation.**
- 3) One page shows no fewer than parameters, can use \uparrow 、 \downarrow key line double check parameters.

7.2 parameter setting

In the parameter setup submenu, press [F1] key, enter the speed parameter setting function, as shown in figure 7.2:



Speed parameters include: Photos are for reference only.

Starting speed - system X, Y axes at the time of starting and stopping the speed (unit: mm or inches per minute, see control parameters, the same below).

Time adjustment - system by starting speed adjustment to the highest speed (the speed) during the process of the time it takes. Unit: seconds.

Uniform acceleration time - In the process of add/deceleration, linear acceleration time is, usually slightly smaller than adjusting time (about nine over ten). Big machine this value accounted for the proportion of smaller.

Highest speed limit - the top speed for manual and execute commands G00 runtime (unit: MM or Inch/Min).

Processing speed limit - the highest in the manufacturing process of flame/plasma processing speed (unit: MM or Inch/Min).

Reset (back to mechanical zero) speed - reset (back to mechanical zero) (unit: MM or Inch/Min).

Back/forward speed - suspended back and forward operation specified speed (unit: MM or Inch/Min).

Corner speed between conversions angle - when the program is running direction change over this point, the system is the corner speed down to starting speed.

General system are heavier, this value is selected. Timing can be according to the tone, the processing speed and machine tool vibration condition. Vibration is big, this value is chosen small.

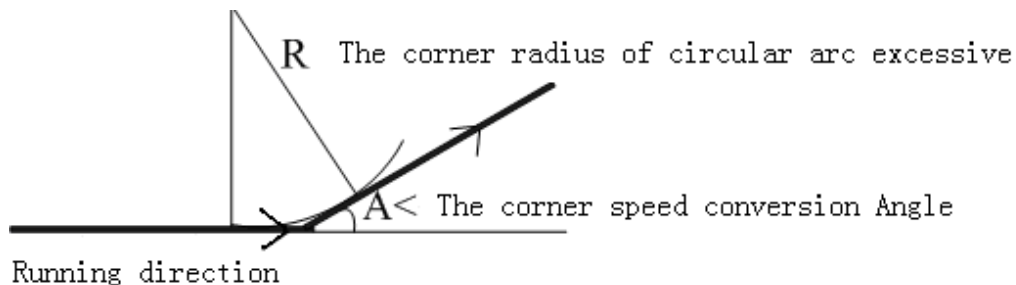

The corner arc transition radius - see the corner.

Arc speed limit - only for the speed limit.

Corner radius arc transition radius, setting and the circular arc of the above the speed limit, when the arc radius is less than this value, according to the circular arc speed operation. The speed limit is set to 0, and arc function is invalid.

7.3 system parameters

In the parameter settings menu, press "F2" button to enter the system parameter setting function, as shown in figure 7.3:

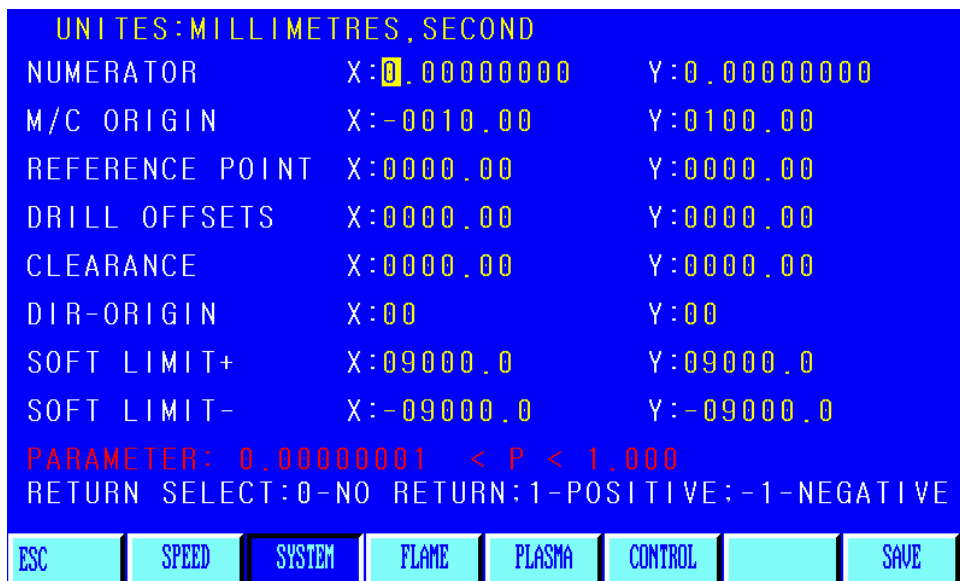

Pulse equivalent - electronic gear molecules and the ratio of the denominator is the pulse equivalent, unit microns, converted to X 1000 MM.

Pulse equivalent calculation formula = screw DISTANCE x 1000 / (360 x score/interval Angle x ratio).

The calculation method of pulse equivalent, adjustment method is as follows:

(1) The first rough set an pulse equivalent, example: 0.002.

(2) Points on the machine tool dynamic walking a standard distance (the longer the more exact), measure the actual walking distance, to the following formula:

Practical run distance / should run distance * original pulse equivalent = new pulse equivalent.

Make type reduction into the simplest fraction.

Example: at the beginning of pulse equivalent, example: 0.002, at 2000 mm, the actual 2651 mm.

2651

$$\frac{2651}{2000} \times 0.002 = 0.002651$$

Machine origin - use connect into switch a special point on the set of machine tools, machine tools without the use of mechanical origin, the origin of the machine tool can be set to zero. (Unit: mm or inch)

Reference point -- the starting point is defined as the process of machining, the system is to run the program (G92) will be automatically generated. (Unit: mm or inch)

Reverse - due to mechanical connection with reverse clearance, clearance system when reverses, it will compensate for clearance. Clearance value is obtained by actual measurement, unit: mm or inches. In general, not advocating a backlash.

Core drill bias - punching or crossed gun relative to the cutting gun offset distance.

Reset direction - the system back to the direction of the mechanical zero, 1 negative, 0, nothing, 1 is reset.

Positive/negative soft limit - when the machine tool coordinate exceeds the soft plus or minus limit values set, alarm system, if when not in use, should be used to set the parameter is greater than the actual value.

7.4 Flame parameters

In the parameter setup submenu, press "F3" button to enter the flame parameter Settings, as shown in figure 7.4:

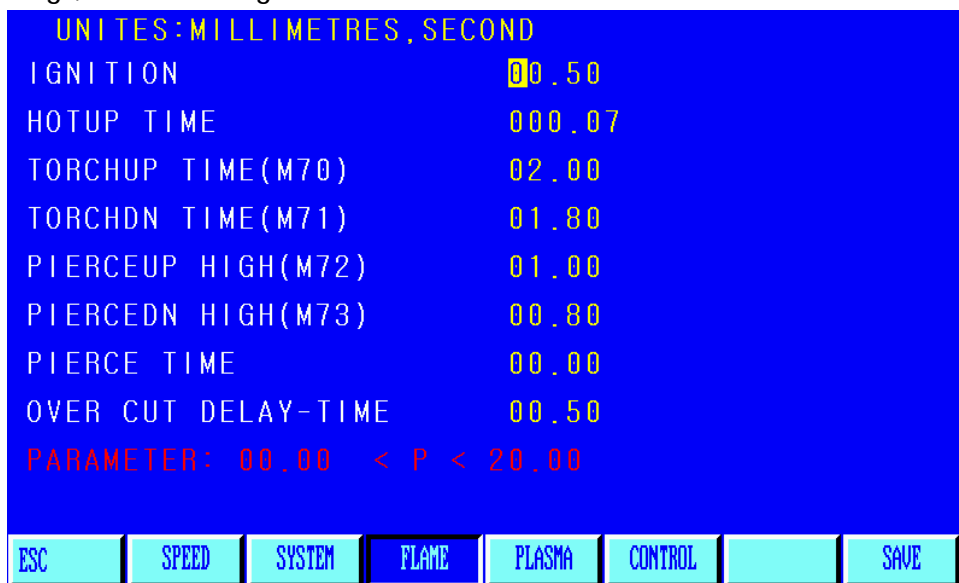

Ignition delay---flame cutting, when performing M20, open the high voltage ignition switch delay time.

Preheat delay---preheat-perforation time (unit: second), the preheating, perforated began after preheating, if the preheating time is not enough, can press 【 pause 】, preheating time delay automatically extend to 150 seconds, if preheating is good, can press the "start" button, the end of the preheating time delay, and will be automatically saved in the preheat time delay parameter.

Cutting up delay -- instructions that are executed (M70) - when the delay time of auxiliary instructions (see 6.4 M), unit: seconds.

Cutting down latency M71-- instructions that are executed (M71) - when the

delay time of auxiliary instructions (see 6.4 M), unit: seconds.

Punch cutting up -- instructions that are executed (M72) - when the delay time (see 6.4 M assisted instruction), unit: seconds.

Punch cutting down -- instructions that are executed (M73) - when the delay time of auxiliary instructions (see 6.4 M), unit: seconds.

Perforated delay -- When flame cutting punch performing M07, - after open the cutting oxygen delay, the cutting decreases.

Expired delay - shut down cutting oxygen, because of rest pressure in the pipe, through delay to next step, in order to improve the cutting surface finish.

Period of time delay --between processes in place after the line movement, via the time delay and then run the next line.

First open another cutting oxygen gun (0/1) - 0 - first rises the gun to open cut again choose 1 - start with cutting oxygen gun.

Use high pre M24 choosing (0/1) - plate punch, need to use high preheating auxiliary, select this feature, open M24 preheating, shut down after preheating.

Pay attention to, don't choose this, the whole process M24 don't open (hot).

Gas use M instructions, open the outlet gas solenoid valve use address (see diagnostic function), if do not use (especially when answering system into the flame and plasma amphibious) to establish the M46.

7.5. Plasma parameters set

Set menu, press [F4] into the plasma parameter settings, as shown in figure 7.5:

| UNITES: MILLIMETRES, SECOND | |
|---|---------|
| LOCATE CHECK(0/1) | 0 |
| LOCATE LOGIC (0-LOW/1-HIG) | 0 |
| TORCH LOCATE TIME | 00.50 |
| TORCHUP TIME(M70) | 02.00 |
| TEMPO DESCENTE (M71) | 01.80 |
| ARC-FEEDBACK(0/1) | 0 |
| MAX TIME FOR ARC-FEEDBACK(S) | 10.0 |
| PIERCE TIME | 00.30 |
| PARAMETER: 0 < P < 1 | |
| RETURN SELECT: 0-NO RETURN; 1-POSITIVE; -1-NEGATIVE | |
| ESC | SPEED |
| SYSTEM | FLAME |
| PLASMA | CONTROL |
| | SAVE |

Positioning detection of choice - when performing M07 instruction, select whether to cutting positioning operation. 0-not position. 1-positioning operation.

Positioning detection logic (0 1 high/low) -- -- position switches normally open 0 (highly effective), normally closed (low effective) choose 1.

Cutting positioning delay

When plasma gun position, cutting down first. when met the lower bit, stop cutting down. And the burning torch up then, after cutting positioning delay stop cutting up (see M75 instruction), unit: seconds.

Cutting up delay M70-- instructions that are executed (M70) - when the delay time of auxiliary instructions (see 6.4 M), unit: seconds.

Cutting down latency M71-- instructions that are executed (M71) - when the delay time of auxiliary instructions (see 6.4 M), unit: seconds

Arc pressure test options -- In plasma operation, whether to detect arc pressure, to make sure form this. (Choose 1) when detecting arc voltage, arc starting to detect when the arc voltage feedback, the runtime to monitor arc voltage feedback. When breaking arc voltage feedback, the system according to suspend processing, and the tip. The general plate processing arc pressure detection. Chose not to detect arc voltage (0). When the ignition switch opens, delay perforation began after processing delay, cutting process, don not detection of arc voltage feedback. The general sheet processing is not to choose arc pressure detection.

Punch time delay - when striking success after perforation delay system normal operation.

Detect arc voltage maximum delay (in seconds) -- choosing arc pressure detecting perforation, if after perforation time more than the "maximum delay", has not yet received successful ignition signal an error, suspend the current work waiting to be processed. After troubleshooting, press [start] to start perforation. The default is 60 seconds.

Perforated delay -- when strike success after perforation, delay system normal operation.

Punch for the first time delay - punch for the first time, because the gun is cold so take a long time delay.

Arc, then open the water spray (0/1) -- table cutting machine, choose cylinder control height, and sheet processing, need to open the water valve, select this option.

Positioning detection choice -- when performing M07 instruction, select whether to cutting positioning operation, choose 1 for cutting positioning operation. The initial positioning of the wiring method will see 10.6 when using plasma cutting typical wiring.

The corner -- shut up distance (corner) transformation in the procedures section, may cause changes in the velocity of the (arc pressure would change, cause drop Gun), so the system automatically shut down when section at the end of the distance away by high control, unit MM.

Shut up speed -- shut down automatically when machining speed is lower than this value higher, it is set to 0, and the function is invalid.

Distance from the finish off arc pressure -- processing is usually a close curve, at the end of the process, start and end point come to together, tend to form the phenomenon of burnt, affect the finish. After selecting this distance, have the distance before the finish, and the automatic power off the arc pressure and higher.

Higher automatic signal delay (in seconds) -- --because when you start cutting, arc voltage is not very stable, start cutting after the delay then open up automatically.

Arc starting with M instructions -- set up arc outlet, the default is M12.

Arc breaking with M instructions -- to break the arc set outlet, default is M 13.

Note: when the arc breaking M instructions than arc M is big 1, indicating that they are one outlet (even to open, and closed), the system controls arc starting switch use level control. When two M instructions are an even number, and are not equal, that is, two output control on and off operation respectively. The system control switches use pulse ignition control, pulse width 0.5 seconds.

7.5 control parameter set

In the parameter setup submenu, press "F5" button to enter the control parameter settings menu, as shown in figure 7.6:

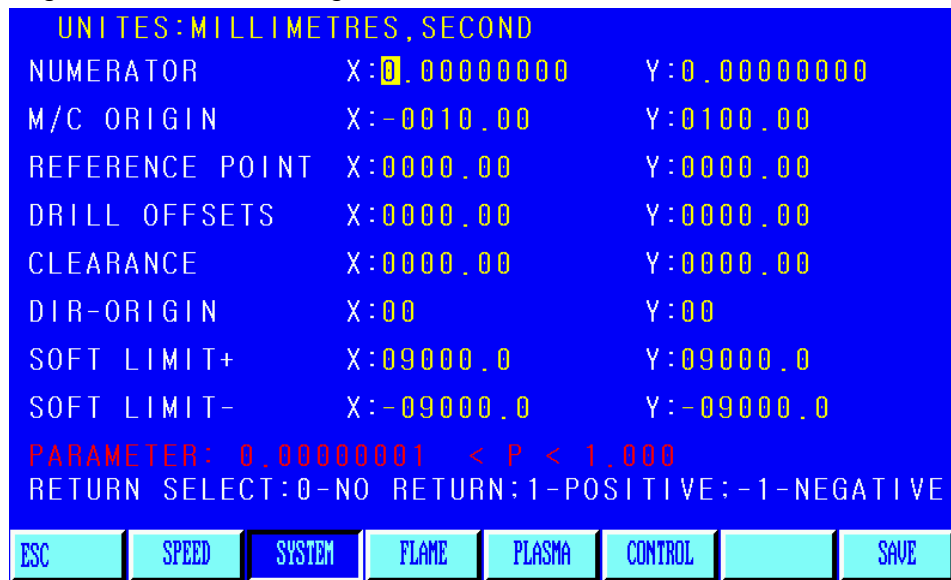

Flame (0)/plasma (1) choice - select 0 when choose a flame processing, plasma process selection 1.

Automatic speed change rate - automatically adjust the speed when the rate of change.

Edge notch choice (0/1) - 0 means don't choose edge of perforation, 1 means choose edge notch.

Steel plate to X width X direction, steel plate width actually, this parameter is only running in heavy work.

Steel sheet to width Y--- The Y direction of the actual height, this parameter is only runs in large work.

Total XZ: 0 / YZ: 1 choice -- because the system can control three axis movement, for there is a requirement for bilateral drive machine, third axis is edge,

with the X axis and Y axis side, in the choice. Choose 0, Z axle with the X axle total side. Choose 1 Z axle and Y axle side.

Inch/metric: 0:1 choice - metric: 0 length parameters, speed, and the value, the coordinates are metric unit (MM), processing English program (G20), but the display is a metric unit (MM). Option 1 inch: parameters, display, coordinates are imperial units (inches), processing metric program (G21), but the display is imperial units (inches).

Calculation accuracy, programming, some nesting software will generate a little burr, set this parameter can be ruled out, the default value is 0.1 MM.

Take over control box to choose (0/1) -- if you use the outside to take over control box, choose 1, otherwise 0.

Wired/wireless remote control to choose (0/1) -- took over control box is wired remote control to choose 0, wireless remote control to choose 1.

G41 / G42 test effective (0/1)– System compensation of validity check (G41 / G42) is correct. When the error is not serious, chose this parameter 0, prompt error line, but don't call the ring, the program can continue.

Choosing processing clean coordinates (0/1) - option 1, before processing, automatic will coordinate to 0. WENTAI(carved) software without G92 instructions for this function.

Cutting air (0/1) - sheet processing, using pneumatic lift than automatically adjustable high effective, optional 1, otherwise 0. Choosing pneumatic elevation, cutting down the M16, effectively cutting torch rise M16 invalid (cancelled).

Processed automatically back to choose (0/1) - option 1, processing after the automatic back to the reference point. External limit effective (0/1) - many small cutting machine for easy without external hard limit, can choose [parameter] - [control] - external limit effective = 0, in order to avoid unnecessary hard limit alarm of failure.

Software limit effectively (0/1) - option 1, soft limit function to take effect.

Bump shot detection (0/1) - if the equipment is equipped with effective bump shot detection (P1 feet using positive limit input port), optional [parameter] - [control] - bump shot detection effectively = 1, the input normally closed connection, in case of collision gun (off), immediately suspend (and submitted to the gun warning).

Note: when using the bump shot detection, must cancel, hardware limit function.

Hit gun with localization testing whether a detecting and locating detection (0/1) -

the wall is the same input port selection.

Hit gun after the suspension of operation (0)/rise gun (1) - 0, bump shot suspended after processing, choose 1, gun automatic after, processing to continue.

Suspended after rising gun (0/1) after choice - if you want to stop, have carried cutting action, optional choose suspended after rising gun = 1.

Cutting length (broken bridge point. MM) - processing when choosing broken bridge function, each cut the length, will automatically set up a broken bridge point.

Broken bridge length (MM) - setting, middle-east blank lines after this distance (bridge) wide, to start cutting.

The main screen text (0/1) - whether under the boot screen, display the text information of the company, this text under the main interface, press GG8 modification.

Option to show slotting compensation line (0/1) - whether display slotting compensation after the coordinates of the track.

Note: when did not understand the parameters of concrete application, please carefully change!

Chapter 8 the gallery features

8.1 Graphics library setup:

Input to the size you want, to get what you need to artifacts.

When the input parameters, control system general inspections of geometry size, there is an error to display warning information.

Note:

- 1) The control system can't check all of the error parameters, as much as possible to input the correct size parameters.
- 2) When you input parameters, the parameters of the control system will be based on the input automatically draw the graphics. This examination is helpful for graphics. Working in the system under the main menu, select the "F6" into the gallery.

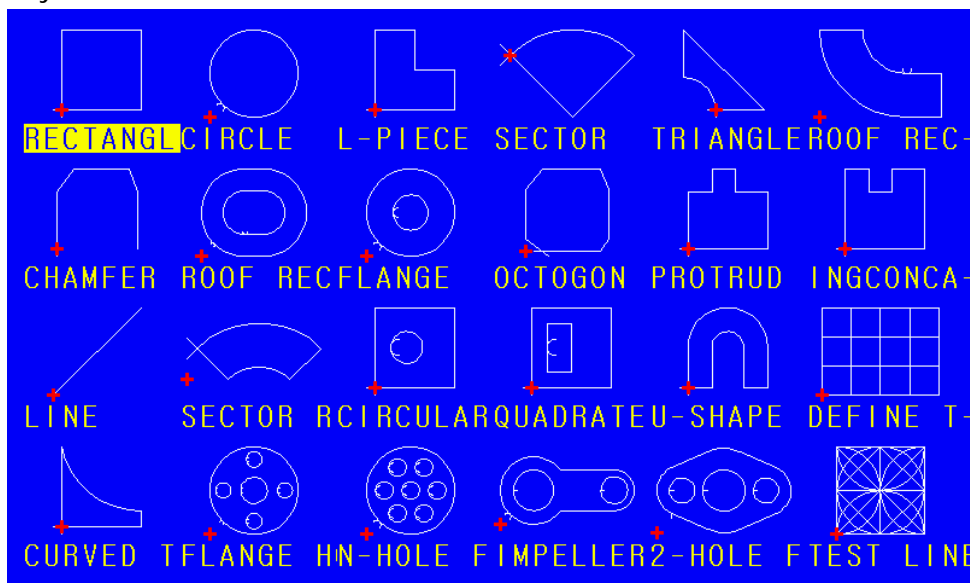

8.2 the selection of graphical parts

At present this system provides 24 graphic unit (can be readily expanded according to customer requirements), press the direction key [up] [down] [left] [right] mobile highlight cursor, choose the required graphics, press "ENTER" key to confirm.

8.3 set of graphical parts and discharge

After the parts according to the last steps selected, upper prompts for various parameters of graphics. As shown in figure 8.2:

【F1】 Artifacts: according to the work piece machining (for effective parts).

【F2】 Hole shape: according to the hole shape processing is made valid by means of the (outside).

【F3】 Rotation: system prompts for rotation Angle and press [ENTER] or F6 submit, display graphics after the rotation. Angle counterclockwise is positive.

【F4】 Arrange material : system prompts input.

Number of lines - array processing line Numbers.

The number of columns - arrange the job number of columns.

Line spacing - the distance between line and line.

Column spacing – The landscape distance of processing pieces

Line offset - interlaced dislocation of the offset. As shown in figure 8.3 schematic diagram:

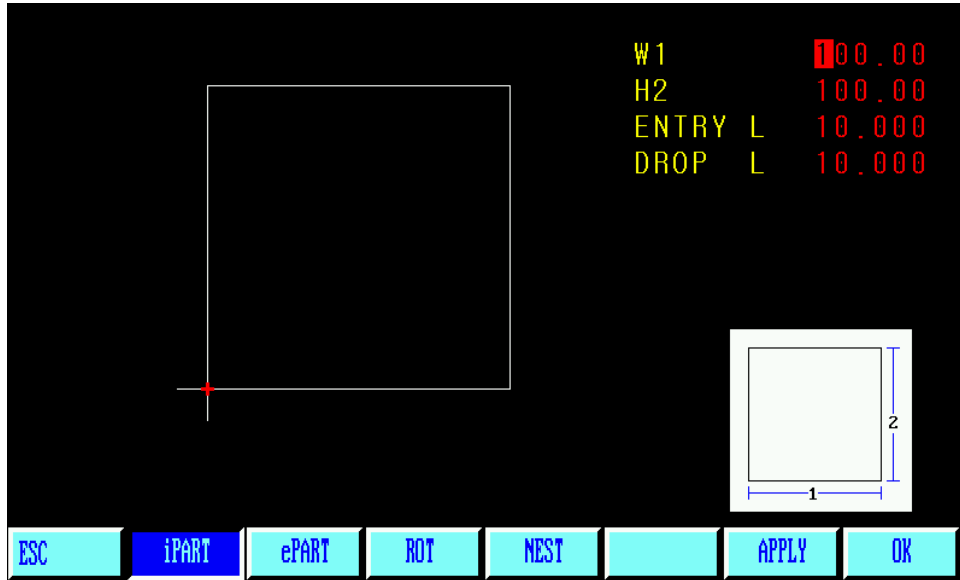

Graph 8.2 Graph set menu

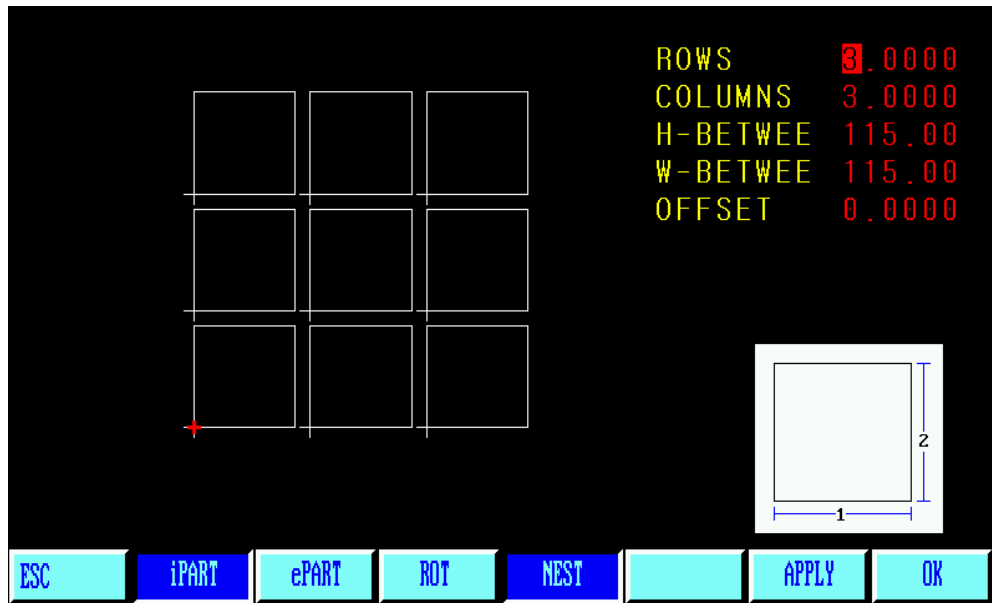

Graph 8.3 Layout diagram

Chapter 9 diagnostic function

In the system work under the main menu, press "F5" button to enter diagnostic function main interface, as shown in the figure below:

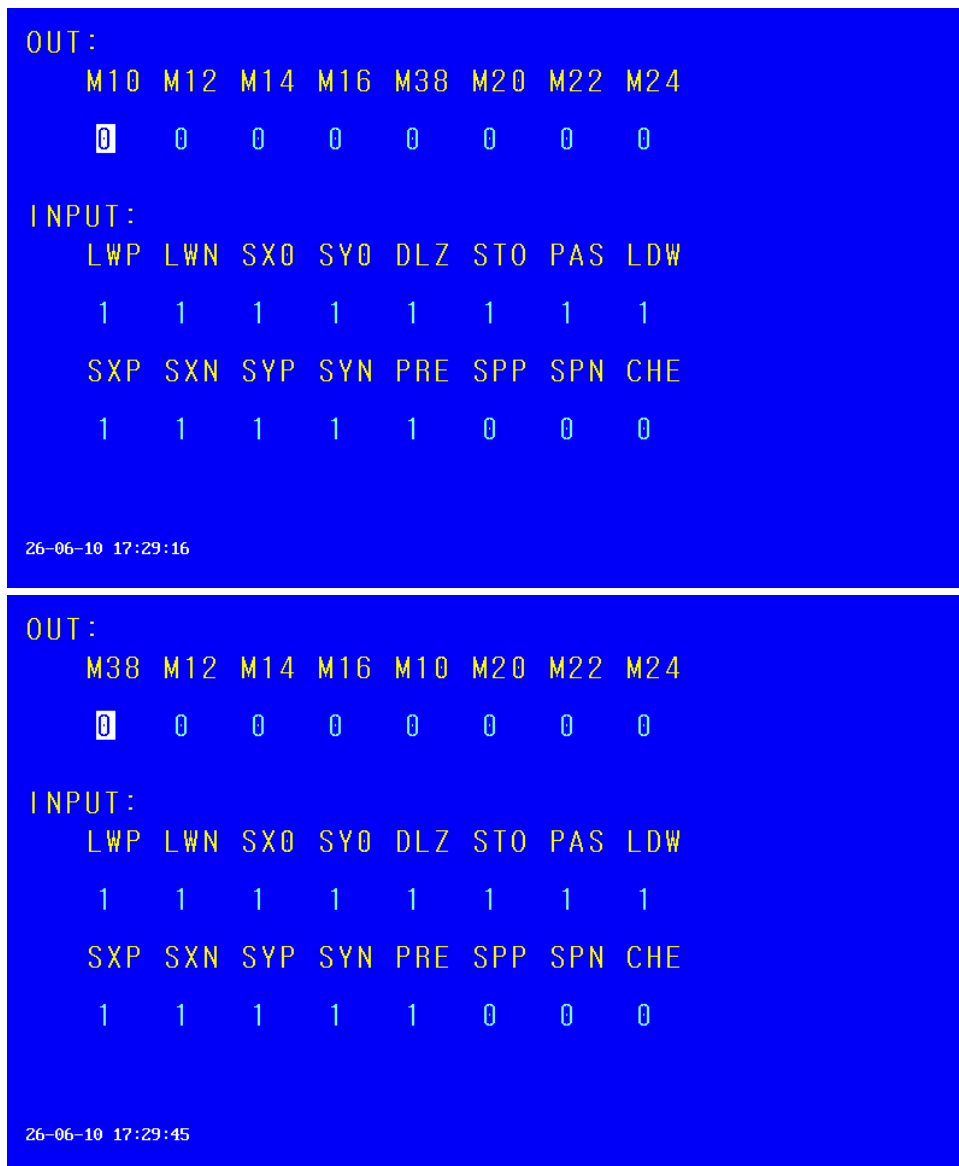

9.1 Input/output interface check

System diagnosis according to the current system of open hardware resources, under the system diagnostic images, can check the input/output interface.

9.2 output check

Every outlet only defines the M address (instruction), move the cursor to the photoelectric isolation at 8 output at any position, with "0" and "1" to change the

output level. Setting 1, 0 means canceled. See the output each port definitions (input/output port definition).

9.3 input inspection

It shows the current photoelectric isolation input state. 0 means low potential (ground), 1 said the port high potential (24 v or hung up). Its input symbol definition can see ports (input/output port definition).

Input diagnosis:

LWP - external is limit (normally closed switch), choosing bump shot detection, the foot a gun testing point.

LWN - external negative limit (normally closed switch).

SX0 / DUP - has two functions, reset direction is valid is X0 mechanical original, it is an external manual, cutting up switch (no lock, normally closed connection).

SY0 / DDN, has two functions, reset direction is valid is Y0 mechanical origin, it is an external manual, cutting down the switch, no lock, normally closed connection).

DLZ - plasma arc mouth (arc starting signal success) measurement, low effective.

STO - external abrupt stop switch (normally closed connection). PAS - external pause switch (normally closed connection).

LDW –before the initial positioning of plasma perforation

SXP SXN SYP SYN PRE - is an external wireless remote control coding input.

SPP SPN CHE - useless interface.

Chapter 10 System input/output interface connected

The system interface: including input/output (DB25 core), the motor (15 core), a wireless remote control (15 core), meet the company production of block.

10.1 the system input principle

Generally limit/start/stop using mechanical switch, to prevent interference to enter, usually use the normally closed contact of a mechanical switch, according to the chart mode connection.

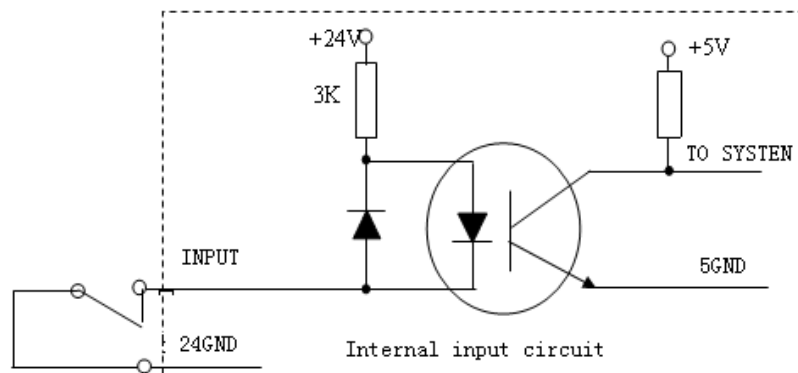

Note:

System requires urgent stop, pause, the logic is consistent, namely by normally open or connected normally closed points (common).

System boot automatically detects the external trigger a state, as a control.

So, if you do not answer the external start switch, the corresponding bit should be received 24 V (similar to answer the normally closed contact) or what all don't pick up (similar to connect normally open contacts).

10.2 the principle of the system output:

Control signal = 0 switch/relay connected (24 V loop formation, low effective signal)

Control signal = 1 switch/relay disconnect (24 V did not form a loop, cancel)

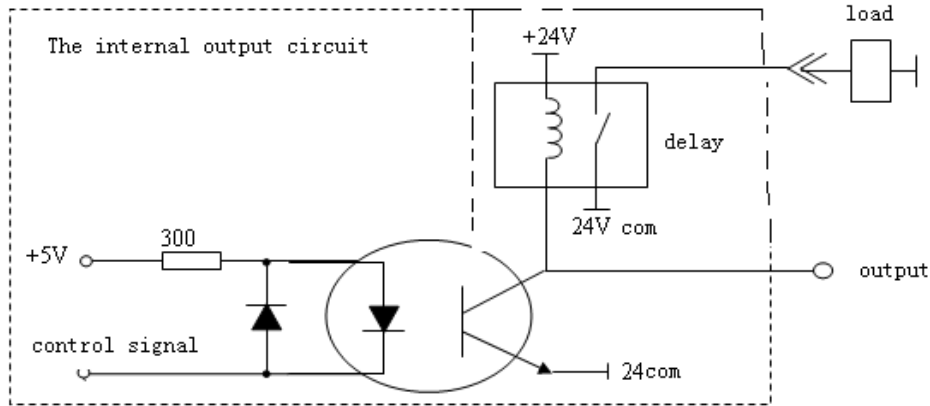

10.3 Input connect definition

| Signal Definition | 25core (hole) | Illustration |
|-------------------|---------------|--|
| X>+ | 1 | X+ limit, two axes is limit concatenated, high effective. If you don't use, please send short signal received 24 V, if do not use the limit, it is a bump shot detection (normally closed) |
| X<- | 14 | X - limit, limit concatenated two axles, high effective. If you don't use, please send short signal received 24 V. |
| Y>+ | 2 | Y+ limit, two axes is limit concatenated, high effective. If you don't use, please send short signal received 24 V, if do not use the limit, it is a bump shot detection (normally closed) |
| Y<- | 15 | Y - limit, limit concatenated two axles, high effective. If you don't use, please send short signal received 24 V. |
| ST0 | 3 | External scram button and high effective, if you don't use, please send short signal received 24 V. |
| SX0 | 16 | X0 mechanical origin, NPN proximity switch, normally is open. Reset the direction is invalid when the mouth for external cutting up key, high effective, if you don't use, please send short signal received 24 V. |
| DLZ | 4 | Detect arc voltage, low effective and high arc pressure when not connected to. |
| SY0 | 17 | Y0 mechanical origin, NPN proximity switch, normally is open. Reset direction is invalid when the mouth as external cutting down key, high effective, if you don't use, please send short signal received 24 V. |
| LDW | 5 | A plasma cutting torch orientation, the lower limit. |
| PAU | 18 | External pause button, high effective, if you don't use, please send short signal received 24 V. |

| | | |
|------|----|-------------------------------|
| COL | 6 | Hit gun signal |
| SXP | 19 | external hand control box X + |
| SXN | 7 | external hand control box X - |
| SYP | 20 | external hand control box Y+ |
| SYN | 8 | external hand control box Y- |
| PRE | 21 | NC |
| 24V地 | 25 | 24V power supply ground |
| 24V地 | 13 | 24V power supply ground |

10.4 output connect definition

| Signal Definition | 25core (hole) | Illustration |
|-------------------|---------------|--|
| M0 | 1 | Oxygen gas and preheating and port on |
| M2 | 14 | Level 3 / arc cutting oxygen (default) |
| M4 | 2 | Cutting A liter, M4 open/ M5 close |
| M6 | 15 | Cutting A drop, M6 open / M7 close |
| M20 | 3 | Flame ignition switch, M20 open/ M21 close |
| M2 | 16 | Line drawing/standby switch, ignition gun M2 on/M3 off |
| M22 | 4 | Water Spray |
| M24 | 17 | High-pressure preheating oxygen/standby switch, M24 open / M25 close |
| M40 | 5 | |
| M8 | 18 | Plasma model, Automatic signal output |
| M2 | 6 | |
| M4 | 19 | |
| M6 | 7 | |
| M8 | 20 | fire mode, Automatic signal output |
| M50 | 8 | |
| M52 | 21 | |
| 24V地 | 25 | 24V power supply ground |

| | | |
|------|----|-------------------------|
| 24V地 | 13 | 24V power supply ground |
|------|----|-------------------------|

10.5 DB15 core motor port definitions

1) Differential signal (2) a total of anode connection

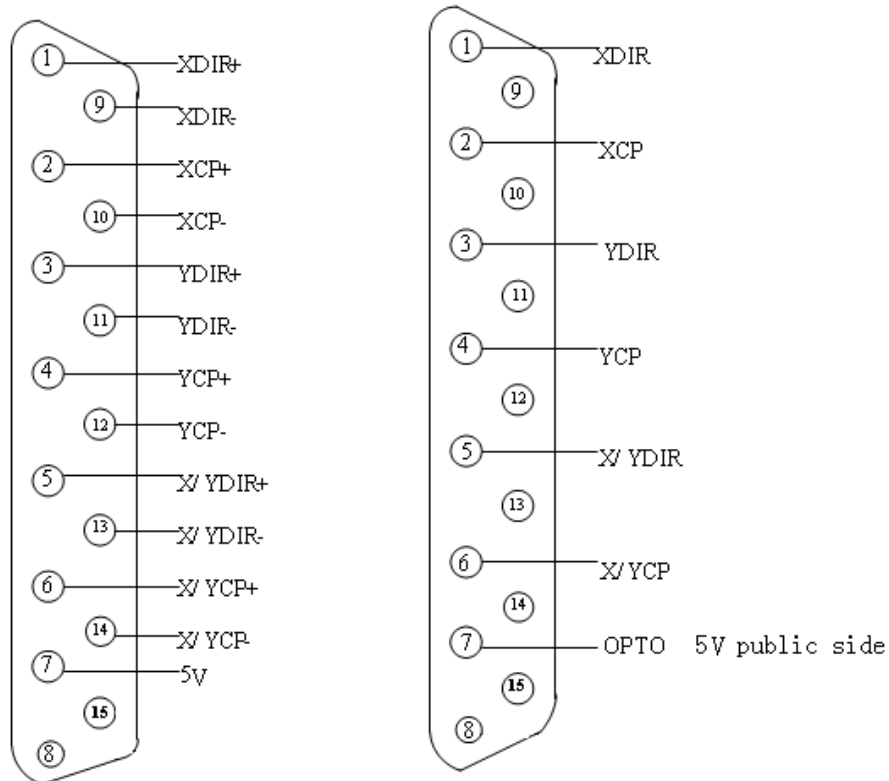

10.6 form a complete set of peripherals connection definition 10.8.1 the company adjust block (SF - HC30) DB15 core joint pin definition

| Number | Definition | Illustration | Comment |
|--------|---------------------|---|---------|
| 1 | Serial port public | 232-COM | |
| 2 | Serial port receive | 232-RXD | |
| 3 | Serial port send | 232-TXD | |
| 4 | Input signal | Arc pressure (the height of the cutting head) | |
| 5 | Signal | Signals of arc voltage | |
| 7、14 | Power supply | 24 V power supply is, highly controller in | |
| 8、15 | Power supply | 24 V power supply, high power supply | |
| 10 | Input | Manual/automatic selection signal controller | |
| 12 | Input | Manual up signal, drive the cutting head up | |
| 13 | Input | Manually down signal, driving down cutting head | |

10.7. wireless hand control (DB15) connection definition

| Number | Definition | Illustration | Comment |
|--------|------------|--|---------|
| 1 | 24V | 24V power | |
| 9 | I8 | Input port 9 and can be used for wireless control box | |
| 10 | I9 | Input port 10 and can be used for wireless control box | |
| 11 | I10 | Input port 11 and can be used for wireless control box | |
| 12 | I11 | Input port 12 and can be used for wireless control box | |
| 13 | I12 | Input port 13 and can be used for wireless control box | |
| 8、15 | 24G | 24V Power | |

10.8 RS232(DB9) connect definition

| Number | Definition | Illustration | Comment |
|--------|------------|---------------|---------|
| 2 | 24V | RS232 send | |
| 3 | I8 | RS232 receive | |
| 5 | I9 | RS232 COM | |

Appendix 1: SF - RF06 wireless hand control box

Type SF - RF06 wireless hand control box, using 2.4 GHz radio frequency transmission and six digits and 3 addressing encryption technology to realize remote control of CNC system. A total of 22 on the remote control buttons, it contains forward back to walk around and start pause, all high voltage control function.

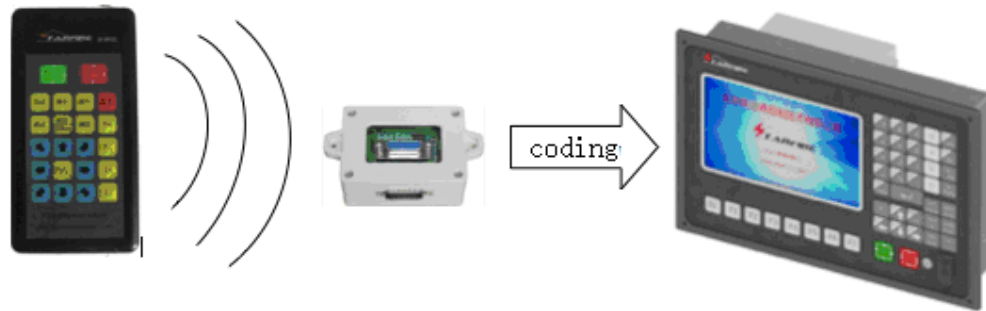



The wireless remote controller

CNC controller

Effective distance 30m

Key Illustration

| Number | Key name | Key function |
|--------|--------------|---|
| 1 | I | Start |
| 2 | 0 | Suspend |
| 3 | Perforated | Perform a complete action to on the perforation |
| 4 | Gas | Open the gas switch |
| 5 | Arc starting | Open cutting oxygen (plasma) switch |
| 6 | Back | During processing, suspended after the original track back |
| 7 | Forward | Aftersuspend processing to move forward |
| 8 | Always | Cut off all of system control output |
| 9 | Shut up | M38 control |
| 10 | S+ | Guns rise control |
| 11 | S- | Guns lowered control |
| 12 | F+ | Welding speed (cutting), power (current) increase control key |
| 13 | F- | Welding (cutting) speed, power cut control keys (current) |
| 14 | # | Forward |
| 15 | \$ | Back |
| 16 | ! | Turn left |
| 17 | " | Turn right |
| 18 | ↖ | Gun head X-, Y+ move |
| 19 | ↘ | Gun head X+, Y- move |
| 20 | ↗ | Gun head X+, Y+ move |

| | | |
|----|---|---|
| 21 |  | Gun head X -, Y- move |
| 22 |  | Feed ratio fast adjustment, press the 5%, press the 80% again |

Wiring definition

| CNC SF-2100C DB15 | | Wireless hand control box DB15core | |
|-------------------|----------------|------------------------------------|----------------|
| Pin Number | Pin Definition | Pin Number | Pin Definition |
| 1 | 24V | 1 | 24V |
| 8 | 24G | 8 | 24G |
| 9 | I8 | 9 | S1 |
| 10 | I9 | 10 | S2 |
| 11 | I10 | 11 | S3 |
| 12 | I11 | 12 | S4 |
| 13 | I12 | 13 | S5 |
| 15 | 24G | 15 | 24G |

Size: (135 * 55 * 16 MM) remote control receiver installation size chart:

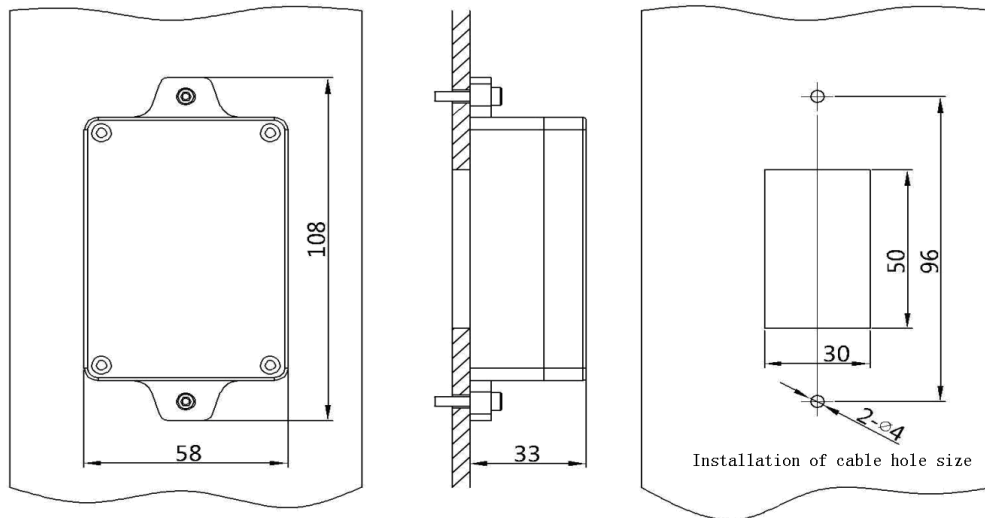

Appendix 2: SF-2100C-AH software upgrade instructions

Function: system can through the U disk, implementation program to upgrade.

Specific operation is as follows:

1. The update file

Copy the upgrade file 'STARTCNC.EXE' to the USB drive.

2. The steps

With your fingers hold down system is the key on the front panel. Turn on the power to the system power on, waiting for system upgrades its interface display screen appears, then to loosen the button.

After inserted U disk, press screen below the F1 key (that is, the screen of the "upgrade" button on the menu), the system will automatically upgrade operation.

3. Upgrades end

If update program successfully, the system will prompt "upgrade success!" And the buzzer will ring.

If program upgrade failure, the system will prompt "upgrade failed!" And the buzzer will ring continuously.

4. Start the new program

Shut off the power and pull out U disk, open the power supply can start the new program. The boot screen will be displayed after the new version of the program.

Note: if the upgrade is not successful, please check the following factors:

- 1) The U disk must be FAT or FAT32 format. The proposal had better use FAT format.
- 2) Upgrade file name must be STARTCNC.EXE.
- 3) The upgrade file must be put in U packing directory.
- 4) Such as in the process of upgrading, did not appear the prompt of the upgrade is complete and updated directly back to the main interface, or upgrade failure caused by other accident.

But first check upgrade file name is correct, U disk, format is correct; When the elimination of the upgrade file and U disk.

After the two factors can be carried out in accordance with the specific operation steps again upgrade operation.

If attempts to upgrade still fail, please call customer service to Beijing STARFIRE control technology co., LTD.

Appendix 3: install size figure

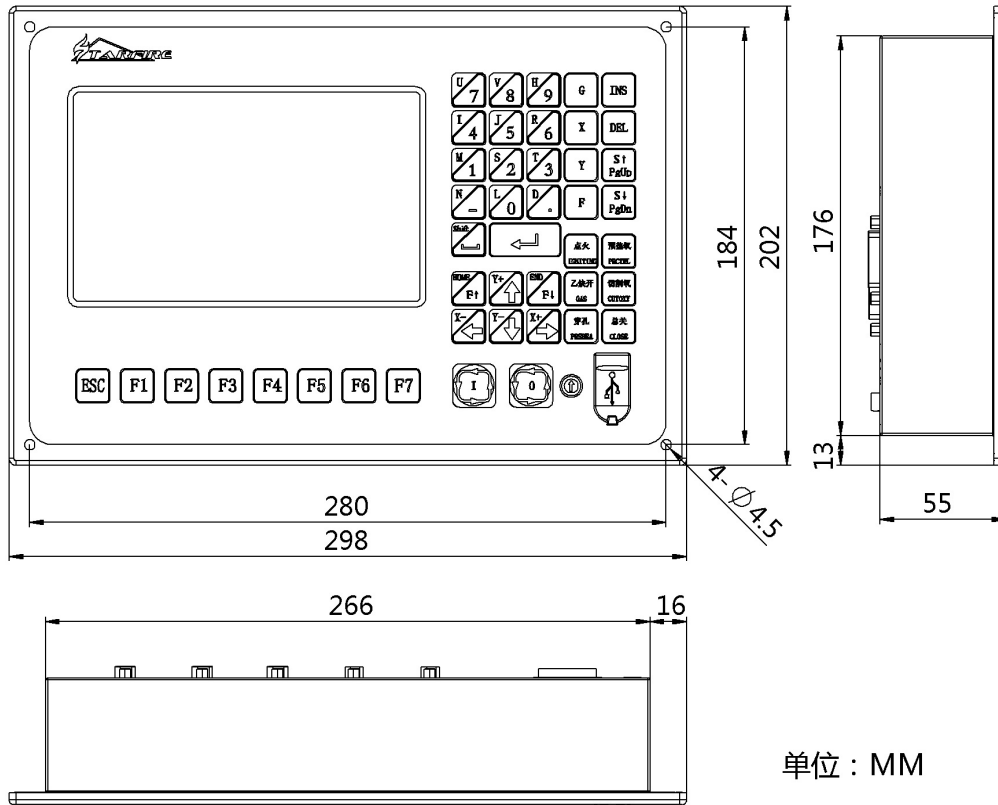

单位：MM

The appendix 4: common troubleshooting

| Fault phenomenon | Failure analysis | Deal way |
|--|---|--|
| To stop work in the same position every time processing | 1. Process problem 2. CNC system software has a problem | Send back program analysis by designers. |
| Machine to stop working, the system normal operation, and the burning torch stopped or just a shaft work | 1. Traveling motor blocked 2. Walking motor fault | Check whether the machine is stuck put smooth |
| When the machine stops working, work system, cutting walking along a certain direction or not go, and press any key (especially the pause button) doesn't work | Machine tool interference crashing | a. Remove interference - note the machine plasma power grounding with machine. b. Motor (old system) and isolation plate c. Flame way, pay attention to the cutting oxygen switch electromagnetic valve is plus arcing processing. |
| Motor is not running | System wiring loose or fall off | Connect again |
| | Drive has set alarm display | Modify driver setting |
| | System startup is zero or too much, control time is too short, electronic gear or pulse equivalent. | Change drive settings, record before modification suggestions to the original parameters |
| | | |
| System response slow | Switching power supply output voltage is not permitted within the scope of action | Adjustment switch power supply output voltage or replace |
| | System parameters is not correct | Change system settings (before modification request to the original parameters for recording). |
| Boot appear limit alarm | The limit switch is not normal | Repair or replace the limit switch |
| | Connecting virtual fall off or excessive | Connect again |
| | Current coordinates systems beyond the limit value | Changes to normal range |
| | Beyond the software limit value | Have reset |

| | | |
|--|--|---|
| | External device or software system fault | To see if the corresponding input port state without change, screen after the repair or replacement |
| Manual and automatic crash | Parameters setting incorrect | First recorded in the system parameters of electronic gear first, then the system main interface, in turn, first press the G, G, and 3, the second into the parameters set to save, restart the system, will note down the electronic gear value fill in the corresponding position, storage parameters after commissioning |
| Input\Output nothing | Input and output wiring loose or fall off | Connect again |
| | 24 V power supply is not normal (25 core voltage) between the 24, 25 feet of the interface | Repair or replace power adapter |
| | | |
| Display not normal | System damage (except escalation cases) | Repair or replace |
| USB interface does not transfer | U disk and the system can't match | Replace the other type or brand of U disk. |
| | The U disk in the wrong format | Reformat for FAT format |
| | System internal loose connection or USB port or pin of different body in it. | To reconnect, clear interface sundry |
| Process starts, automatic return to the main interface | If no longer appears, can explain the procedure of this problem | Check program |
| System can only be opened machining line cannot be the whole round | | Initialization of system parameter |
| | If normal, check the program | Check or send back the department |
| Solenoid valve or plasma arc screen flash | Plasma power supply, system machine shell without a total ground | Put the plasma power supply, system, machine shell, and connected to the earth, connecting squared diameter should be greater than 2mm ² ; |

| | | |
|---------------------------------|--|---|
| | System of input and output, no use the shielded wire. | System input, output, use the shielded wire, and the thru of the exposed part is not greater than 30 mm. |
| | Do not use the input no grounding power | Will not use the 24 V input and ground short connection. |
| | | Between 24 V earthed and the shell (i.e., shielded wire) plus a 0.01 uF capacitance |
| | | Add isolation transformer (380 V ~ 220 V) and interference suppressor. |
| | Power supply loose connection each other | High power welding machine/cutting machine working power supply should be separated from system power supply. |
| Program cannot store or garbled | | Under the main menu, press GG 3, select the file format, operation after the shutdown, restart again. |
| System output point is invalid | 24 V power supply damage or loose connection each other (measure the voltage between 24 and 25 feet) | Replace power adapter, or connection again. |
| | System back relay installed loose or damaged (the relay operation is normal, contact is valid). | To install relay or replacement |